

# QOS-AWARE DOWNLINK SCHEDULING ALGORITHM FOR LTE NETWORKS: A CASE STUDY ON EDGE USERS

A THESIS  
SUBMITTED TO THE DEPARTMENT OF  
ELECTRICAL AND COMPUTER ENGINEERING  
AND THE GRADUATE SCHOOL OF ENGINEERING AND SCIENCE  
OF ABDULLAH GUL UNIVERSITY  
IN PARTIAL FULFILLMENT OF THE REQUIREMENTS  
FOR THE DEGREE OF  
MASTER OF SCIENCE

By  
Osman Gökhan Uyan  
December 2016

Osman Gökhan Uyan QOS-AWARE DOWNLINK SCHEDULING ALGORITHM FOR  
AGU  
LTE NETWORKS: A CASE STUDY ON EDGE USERS  
2016

QOS-AWARE DOWNLINK SCHEDULING  
ALGORITHM FOR LTE NETWORKS:  
A CASE STUDY ON EDGE USERS

A THESIS  
SUBMITTED TO THE DEPARTMENT OF  
ELECTRICAL AND COMPUTER ENGINEERING  
AND THE GRADUATE SCHOOL OF ENGINEERING AND SCIENCE  
OF ABDULLAH GUL UNIVERSITY  
IN PARTIAL FULFILLMENT OF THE REQUIREMENTS  
FOR THE DEGREE OF  
MASTER OF SCIENCE

By  
Osman Gökhan Uyan  
December 2016

## SCIENTIFIC ETHICS COMPLIANCE

I hereby declare that all information in this document has been obtained in accordance with academic rules and ethical conduct. I also declare that, as required by these rules and conduct, I have fully cited and referenced all materials and results that are not original to this work.

Osman Gökhan Uyan

## REGULATORY COMPLIANCE

M.Sc. thesis titled “**QOS-AWARE DOWNLINK SCHEDULING ALGORITHM FOR LTE NETWORKS: A CASE STUDY ON EDGE USERS**” has been prepared in accordance with the Thesis Writing Guidelines of the Abdullah Gül University, Graduate School of Engineering & Science.

Prepared By

Advisor

Osman Gökhan Uyan

Assoc. Prof. V.Cagri Gungor

Head of the Electrical and Computer Engineering Graduate Program

Assoc. Prof. V.Cagri Gungor

## ACCEPTANCE AND APPROVAL

M.Sc. thesis titled “**QOS-AWARE DOWNLINK SCHEDULING ALGORITHM FOR LTE NETWORKS: A CASE STUDY ON EDGE USERS**” and prepared by Osman Gökhan Uyan has been accepted by the jury in the Electrical and Computer Engineering Graduate Program at Abdullah Gül University, Graduate School of Engineering & Science.

28 /12 / 2016

### JURY:

Assoc. Prof. V. Çağrı GÜNGÖR : .....

Prof. Dr. İbrahim DEVELİ : .....

Assist. Prof. M. Şükrü KURAN : .....

### APPROVAL:

The acceptance of this M.Sc. thesis has been approved by the decision of the Abdullah Gül University, Graduate School of Engineering & Science, Executive Board dated ..... /..... / ..... and numbered .....

..... /..... / .....

Graduate School Dean

Prof. İrfan ALAN

## ABSTRACT

### QOS-AWARE DOWNLINK SCHEDULING ALGORITHM FOR LTE NETWORKS: A CASE STUDY ON EDGE USERS

Osman Gökhan Uyan

MSc. in Electrical and Computer Engineering

**Supervisor:** Assoc. Prof. V. Çağrı GÜNGÖR

December 2016

4G/LTE (Long Term Evolution) is the state of the art wireless mobile broadband technology. It allows users to take advantage of high internet speeds. It makes use of the OFDM technology to offer high speed, which supplies the system resources both in time and frequency domain. The allocation of these resources is operated by a scheduling algorithm running on the base station.

In this thesis, we investigate the performance of existing downlink scheduling algorithms in two ways. First we look at the performance of the algorithms in terms of throughput and fairness metrics. Second, we suggest a new fairness criterion, QoS-aware fairness which accepts that the system is fair if it can supply the users with the packet delays that they demand, and we evaluate the performance of the algorithms according to this metric. We also propose a new algorithm according to these two metrics, which especially increase the throughput gained by the edge users, the QoS-fairness, and classical fairness of the system without causing a big degradation in cell throughput when compared to other schedulers.

*Keywords: LTE, 4G, Scheduling, Resource Allocation, QoS Aware Fairness.*

## ÖZET

# LTE AĞLARI İÇİN SERVİS KALİTESİ ODAKLI AŞAĞI YÖNLÜ ZAMANLAMA ALGORİTMASI: KENAR KULLANICILARI ÜZERİNE İNCELEME

Osman Gökhan Uyan  
Elektrik ve Bilgisayar Mühendisliği Bölümü Yüksek Lisans  
**Tez Yöneticisi:** Doç. Dr. V. Çağrı GÜNGÖR

Aralık 2016

4G/LTE (Long Term Evolution) en modern kablosuz mobil genişbant teknolojisidir. LTE-A kullanıcıların yüksek bağlantı hızlarına ulaşmalarını sağlar. Bu yüksek hızları sağlayabilmek için OFDM teknolojisini kullanır; OFDM sistem kaynaklarını hem frekans hem de zaman alanlarında sunar. Bu kaynakların atanması işi baz istasyonunda çalışan bir zamanlama algoritması tarafından yapılır.

Bu tezde, mevcut zamanlama algoritmaları iki şekilde değerlendirilmektedir. Önce algoritmaların performansları çıktı ve adillik yönüyle incelenmektedir. Daha sonra, yeni bir adillik ölçütü sunulmaktadır: QoS-haberdar adillik; sistemin, kullanıcıların bekleme zamanı taleplerine cevap verebildiği ölçüde adil olduğunu varsayar. Yine mevcut algoritmaların performansları bu ölçü ile incelenmiştir. Ayrıca bu metriklere göre özellikle hücre kenar kullanıcılarının elde ettiği çıktılarını, sistemin adillikini ve klasik adillik artırırken diğer algoritmalarla kıyaslandığında hücre toplam çıktısında çok büyük düşüşe neden olmayan yeni bir algoritma önerilmektedir.

*Anahtar kelimeler: LTE, 4G, Zamanlama, Kaynak Atama, QoS Haberdar Adillik.*

# Acknowledgements

First of all, I would like to extend my thanks to my Supervisor, Assoc. Prof. V. Çağrı Güngör for his motivation and moderation. He encouraged me highly during this thesis, and helped me a lot with his brilliant ideas throughout the research and writing phase of the thesis.

Secondly, I would like to thank to my family, and preeminently my wife, for their patience and tolerance during my studies, especially when I had been exhausted of working several hours on the thesis.

# Table of Contents

<b>1. INTRODUCTION .....</b>	<b>1</b>
1.1 BACKGROUND.....	1
1.2 GOAL OF THE THESIS .....	2
1.3 RELATED WORK .....	3
1.4 OUTLINE OF THESIS .....	12
<b>2. LONG TERM EVOLUTION (LTE) / 4G.....</b>	<b>13</b>
2.1 ASPECTS OF LTE.....	13
2.2 ARCHITECTURE OF LTE .....	15
2.2.1 <i>The User Equipment</i> .....	15
2.2.2 <i>The Radio Access Network (E-UTRAN)</i> .....	16
2.2.3 <i>The Core Network (EPC)</i> .....	17
2.3 LTE-A .....	18
2.3.1 <i>Carrier Aggregation</i> .....	19
2.3.2 <i>Multiple Input Multiple Output (MIMO)</i> .....	20
2.3.3 <i>Relay Nodes</i> .....	21
2.3.4 <i>Coordinated Multi Point Operation</i> .....	22
<b>3. LTE DOWNLINK PHYSICAL LAYER.....</b>	<b>23</b>
3.1 ORTHOGONAL FREQUENCY DIVISION MULTIPLEXING .....	23
3.2 FRAME STRUCTURE .....	25
3.3 RESOURCE GRID .....	26
3.4 CHANNEL CODING .....	28
3.5 LINK ADAPTATION.....	30
<b>4. SCHEDULING .....</b>	<b>32</b>
4.1 TYPES OF SCHEDULING ALGORITHMS .....	33
4.2 ROUND ROBIN ALGORITHM .....	34
4.3 BLIND EQUAL THROUGHPUT ALGORITHM .....	35
4.3 MAX-MIN ALGORITHM.....	36
4.4 BEST-CQI ALGORITHM.....	36
4.5 PROPORTIONAL FAIR ALGORITHM .....	37
4.6 PROPOSED ALGORITHM.....	38
<b>5. LTE SYSTEM LEVEL SIMULATOR.....</b>	<b>42</b>
5.1 BLOCKS OF THE SIMULATOR .....	42
5.2 STRUCTURE OF THE SIMULATOR .....	43
5.3 SIMULATION TYPES .....	44
<b>6. PERFORMANCE EVALUATIONS.....</b>	<b>46</b>
6.1 EDGE THROUGHPUT RESULTS.....	47
6.2 PEAK THROUGHPUT RESULTS .....	48
6.3 AVERAGE CELL THROUGHPUT RESULTS.....	50
6.4 JAIN'S FAIRNESS METRIC RESULTS.....	51
6.5 QoS FAIRNESS METRIC RESULTS .....	52
6.6 EFFECTS OF MOBILITY .....	53
6.7 EFFECTS OF CARRIER FREQUENCY.....	59
6.8 EFFECTS OF ANTENNA CONFIGURATION (MIMO) .....	64
<b>7. CONCLUSIONS AND DISCUSSION .....</b>	<b>68</b>
<b>8. BIBLIOGRAPHY .....</b>	<b>70</b>

# List of Figures

Figure 1.1 Depict of objectives of algorithm.....	4
Figure 2.1 High-level LTE Architecture .....	15
Figure 2.2 Carrier Aggregation .....	19
Figure 2.3 A 2x2 MIMO .....	20
Figure 2.4 Relay Node.....	21
Figure 2.5 Coordinated Multi Point.....	22
Figure 3.1 Example of four subcarriers in time and frequency domains. ....	24
Figure 3.2 Type-1 Frame Structure .....	26
Figure 3.3 LTE Resource Grid .....	27
Figure 3.4 Convolutional Encoder with $k=1$ , $n=3$ , $m=6$ .....	29
Figure 3.5 LTE Turbo Encoder Structure .....	29
Figure 4.1 CSI – Scheduler diagram .....	33
Figure 4.2 Channel-aware Scheduling .....	34
Figure 4.3 Round Robin Scheduling Example .....	35
Figure 4.4 Best-CQI Scheduling Example .....	37
Figure 5.1 Simulation Types .....	44
Figure 6.1 Average Edge Throughput Performance of the Schedulers.....	47
Figure 6.2 Positions of the UEs and the eNodeBs .....	48
Figure 6.3 Average Peak Throughput Performance of the Schedulers .....	49
Figure 6.4 Average Cell Throughput Performance of the Schedulers .....	50
Figure 6.5 Jain’s Fairness Index of the Schedulers .....	51

Figure 6.6 QoS Fairness Index of the Schedulers .....	52
Figure 6.7 Average Peak Throughput with Mobility .....	54
Figure 6.8 Average Edge Throughput with Mobility.....	55
Figure 6.9 Average Cell Throughput with Mobility .....	56
Figure 6.10 Jain's Fairness Index Results with Mobility.....	57
Figure 6.11 QoS Fairness Index Results with Mobility .....	58
Figure 6.12 Average Peak Throughput with Carrier Frequency .....	59
Figure 6.13 Average Edge Throughput with Carrier Frequency.....	60
Figure 6.14 Average Cell Throughput with Carrier Frequency .....	61
Figure 6.15 Jain's Fairness Index Results with Carrier Frequency.....	62
Figure 6.16 QoS Fairness Index Results with Carrier Frequency .....	63
Figure 6.17 Average Edge Throughput with MIMO .....	64
Figure 6.18 Average Cell Throughput with MIMO .....	65
Figure 6.19 Jain's Fairness Index Results with MIMO.....	66
Figure 6.20 QoS Fairness Index Results with MIMO.....	67

# List of Tables

Table 1.1 List of symbols .....	5
Table 1.2 PET Algorithm of Sudheep and Rebekka .....	6
Table 1.3 Algorithm of Alqahtani and Alhassany.....	7
Table 1.4 Comparison of the Related Work.....	11
Table 3.1 Subcarrier Spacing .....	28
Table 3.2 Modulation vs CQI.....	31
Table 4.1 Proposed Scheduling Algorithm .....	41
Table 6.1 Simulation Parameters.....	46
Table 7.1 Proposed Algorithm vs. Proportional Fair Algorithm.....	68

# Chapter 1

## 1. Introduction

In this chapter, we introduce an overview and background of the thesis while we give the motivation and the scope behind it.

### 1.1 Background

Since the introduction of the first generation Mobile Telecommunication Systems, mobile telecommunication technology has been developed rapidly. From the first analogue systems which were introduced in early 1980s, to the latest broadband technology we use today, highly increasing data transmission speeds has added many new features to the mobile networks and provided the users with new multimedia applications. These developments caused mobile data traffic to grow 4,000-fold over the past 10 years and almost 400-million-fold over the past 15 years. It is also expected to grow another 10-fold until year 2020 [1].

Third Generation Partnership Project (3GPP), the global mobile communication standards developing organization, has been working on new technologies to meet this traffic demand and presented the standard (4G/LTE) with Release 8 in year 2008. LTE simply consists of two sub-networks: Evolved-Universal Terrestrial Radio Access Network (E-UTRAN) and Evolved Packet Core. E-UTRAN is introduced with LTE, and it is the interface between eNodeB and user equipments. It employs Orthogonal Frequency Division Multiple Access (OFDMA) for downlink connections which can allow to reach high data speeds with low latencies. OFDMA is based on Orthogonal Frequency Division Multiplexing (OFDM). In OFDM, a large number of closely spaced orthogonal sub-carrier signals are used to carry data on several parallel data streams or channels [2]. It allocates resources in both time and frequency domains. In time domain, a 10ms

radio resource unit is called a frame, and it consists of 10 subframes which are all 1ms long. On the frequency domain side, there are multiple sub-carriers each of which have 15 KHz bandwidth. Half of a subframe (0.5ms) from time domain and 12 sub-carriers from frequency domain form a Resource Block (RB). These Resource Blocks are allocated to users every 1ms which we call a Transmission Time Interval (TTI). The process of this allocation of resources is named Scheduling. Scheduling is executed on MAC layer using an appropriate algorithm.

3GPP Organization have not defined a standard algorithm for the scheduling mechanism in LTE specifications, which means that a service provider is free to choose a suitable one among a variety of scheduling algorithms. This freedom has been an inspiration for both scientists, mobile network corporations and mobile operators to bring about several different scheduling algorithms. Since scheduling has a serious effect on the conduction of the system, success of the scheduling algorithm is an important issue for system management.

## **1.2 Goal of the Thesis**

There are several well-known algorithms in the literature such as Round Robin, Proportional Fair, Best-CQI and Max-Min algorithms. Each of these algorithms have different fairness and system throughput performances. The goal of this thesis is to investigate efficiency of some of these well-known algorithms not only about fairness and throughput issues but also with a new metric that we define, as well as proposing a new algorithm which performs better than the existing algorithms on the remarked metrics.

The new metric we define is the “QoS-awareness” of the algorithm, which means, an algorithm is accepted as fair, or successful, if it can fulfil the instantaneous bandwidth request of any user. To explain this briefly, we consider that the mobile network users are using different mobile services at a definite time. For example, one user might be making a search on the web, while another one is using VoIP or

sending an SMS. The bandwidth needed for all these three services are different. We can say that the system is fair if all of the users are satisfied when using their desired mobile service at a time.

On the next step, we propose a new scheduling algorithm. The algorithm first acts like a classical scheduling algorithm, it tries to maximize the classical fairness of the system and in like manner give users around the cell edge more bandwidth to satisfy their requests while trying not to cause a noticeable degradation in overall system throughput. The algorithm is also a type of QoS-aware algorithms. It takes the bandwidth needs of the users into account and tries to fulfil the request of the users with the services they use at a palpable time.

For the evaluation task, we prepare several scenarios with a variety of parameters, especially considering the 4G network used in Turkey since April 2016. We engaged Vienna LTE System Level Simulator [3] of Vienna Technical University Institute of Telecommunications.

### **1.3 Related Work**

Scheduling is a very popular subject in the area of LTE and it has attracted many researchers and corporations to put on some effort designing new algorithms. This is why there are several studies about scheduling algorithms in the literature. The aspiration of every algorithm changes commonly around system throughput and fairness.

The important issue about these two metrics is that there is a trade-off between them. To improve the system throughput, more resources are allocated to users which are closer to cell center or which have good connection conditions. As the users close to cell edge get low number of resources compared to others, this approach decreases the fairness of the system. Contrarily, if the scheduler lends more resources to the users close to cell edge or which have atrocious connection conditions, overall system throughput will decrease while the fairness of the system

increases, as all users get convenient number of resources at a time. This is the essential logic of us offering the new QoS-awareness metric for determining the fairness of the system as pointed out in the previous section.

The extant algorithms in the literature oftentimes attend to improve one of the classical metrics while trying to keep the degradation in the other metric as limited as possible. A depict of their approach is given in Figure 1.1, and some scheduling algorithms from the literature are explained below. For amenity, the symbols which will be used throughout the algorithm definitions are committed in Table 1.1.

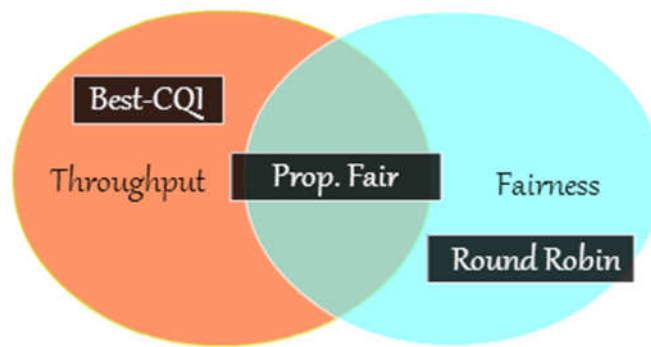

**Figure 1.1 Depict of objectives of algorithm**

The most acclaimed algorithm among all is the Proportional Fair algorithm, and there are a number of studies with references [4]. It was first designed for CDMA systems to be used on time-domain scheduling only. Kim H, and Han Y, expanded this algorithm so that it can be used with OFDM in both frequency and time domain [5]. Notwithstanding, this algorithm was computationally complex and it was hard to use in a real-time system. Found on this algorithm, Sun Z. et al. offered a low-complexity PF algorithm which decreases average latency about 52% and maximum latency about 36% producing results close to optimal PF algorithm [6]. This new algorithm reduced the computational complexity while performing similar performance with the previous version.

Symbol	Description
$N_{RB}$	Number of Resource Blocks
$N_{UE}$	Number of User Equipments (Users)
$RB_N$	Resource Block per UE
$U$	User index
$m$	User
$n$	Sub-carrier
$UE$	UEs waiting to be allocated resources
$CQI$	Channel Quality Index feedback
$R, r$	Past average throughput of UE
$T$	Average data transfer rate
$t_c$	Frame size
$C_{n,m}$	Spectral efficiency
$C_{mean}$	Average spectral efficiency
$QoS$	Quality of Service indicator

**Table 1.1 List of symbols**

Another famous algorithm is called Blind Equal Throughput (BET) algorithm [7]. This algorithm uses a memory to store the average throughput achieved by each user in the past window, and it uses this information as a metric for calculating the weight of each user for allocating resources. BET maintains fairness among all users without taking their channel conditions into consideration, thence it is called 'blind'. Weight of a user for next TTI is evaluated as the inverse of its average throughput up to then:  $M_i = 1/R_i(t)$ ; where  $R_i(t)$  is the prior average throughput of the  $i^{th}$  user.

Sudheep and Rebekka introduced another algorithm called Proportional Equal Throughput (PET) [8], which is a hybrid of PF and BET algorithms. They allot the RBs with a fraction to the users in a TTI. Instead of giving all RBs in a bandwidth to one user, they divide the RBs in to proportions so that they can be given to other

users whose weights follow the user with the maximum weight. Their simulation results show that the PET algorithm gives good performances about fairness compared to BET without causing a considerable decrease in system throughput. Table 1.2 shows the pseudo-code for PET algorithm.

---

**Algorithm Proposed in [8]**

---

1. **Input:**  $N_{RB}$  and  $N_{UE}$
  2. **Compute:**  $RB_N$
  3. **Compute:** user index  $U = \text{rand}(N_{UE})$
  4. **for each** RB
    5. **Compute:**  $r_i = 1/R_i$
    6. **select** UEs with  $\max(r_i)$
    7. **Allocate** RBs to user  $U$  in a defined proportion
  8. **Output:** RB allocation matrix.
- 

**Table 1.2 PET Algorithm of Sudheep and Rebekka**

AlQahtani and Alhassany came up with a novel algorithm. It behaves like classical Round Robin as far as all users share same number of RBs. Subsequently it starts acting like Best-CQI algorithm, and allots the remaining RBs to the users with topmost CQI values [9]. It performs better than Best-CQI in terms of fairness but reduces overall system throughput oppositely. The algorithm is demonstrated in Table 1.3.

---

**Algorithm Proposed in [9]**

---

- 1. Input:**  $N_{RB}$  and  $N_{UE}$
  - 2. Compute:**  $RB_N$
  - 3. if**  $CEIL(RB_N) == FLOOR(RB_N)$
  4.     allocate equal # of RBs to each UE
  - 5. else** allocate equal # of RBs to each UE and lend remaining RBs randomly
  - 6. Compute:** user index  $U = rand(N_{UE})$
  - 7. for each** U
  8.     **select** RBs with  $\max(CQI)$
  9.     **Allocate** RBs to user U
  - 10. Output:** RB allocation matrix.
- 

**Table 1.3 Algorithm of Alqahtani and Alhassany**

There are also a variety of QoS aware algorithms in the literature since QoS has become a popular topic with the development of new network services and applications. Some QoS aware algorithms in the literature will be described below.

Liu and Lee propound Earliest Deadline First (EDF), a QoS-aware algorithm, aiming at avoiding headline expiration [10]. In internet services, guaranteed delay needs that a packet must be delivered before an assured time limit to fend dropping packets off. EDF schedules the packets with the impending deadlines. Nonetheless, besides being QoS-aware, EDF is channel-unaware, that is, it does not take CQI into account. As a consequence of this feature, it is not very suitable to use with mobile networks because channel characteristics may change rapidly in a wireless broadband connection and a packet still might not be delivered on a bad quality channel on time. To cope with this issue, Bin, Hui and Xu suggested a combined version of EDF and PF, which is more convenient to be used in mobile networks [11]. M-EDF-PF is both channel aware and QoS aware; as it takes fairness characteristic of PF and limited delay guaranteed characteristic of EDF. It is suitable to be used with real-time services like video broadcasting or VoIP.

Trabelsi and Selem propose a Decoupled-Level QoS aware scheduling algorithm which tries to guarantee QoS for different traffic types by keeping reasonable values of throughput and fairness [12]. In first step, the algorithm checks if a UE has a packet in buffer and if so, it separates the users into two groups: GBR (Guaranteed Bit Rate) and non-GBR. After the selection, the scheduler serves the GBR list using Best-CQI approach and then moves to non-GBR list and serves the users according to highest priority packet.

Akyildiz and Akkuzu has come up with a QoS algorithm that works in a similar manner with [12]. The scheduler also divides the UEs into two groups according to their traffic type. If a user has a UDP traffic, it is placed into primary list and if it has a TCP traffic, it is placed into the secondary list. After the separation of the users into two lists, the scheduler works as the Best-CQI algorithm and gives resources first to the primary list and then the secondary list according to this approach [13].

Zaki and Weerawardane proposed another QoS-aware algorithm. Their algorithm, LTE MAC, categorizes the incoming packets into five different QoS classes. The top two QoS classes are accepted as GBR, and the other three classes are accepted as non-GBR bearers [14]. The algorithm applies strict scheduling with giving priority to the GBR bearers and then starts with scheduling of non-GBR bearers.

Ferdosian and Othman has proposed a new scheme which again divides the mobile traffic into GBR and non-GBR groups. There are four services grouped as GBR which are conversational voice, conversational video (live-streaming), online gaming and non-conversational video (buffered-stream). On the other hand, there are five services grouped as non-GBR which are IMS signaling, TCP-based video, voice-video (live-streaming), and voice-video (buffered-streaming). They design a mathematical utility function the evaluate the ranks of the bearers about their

desired performance targets. After classifying the bearers, they use the same manner with the Proportional Fair algorithm to assign the RBs to the UEs [15].

Al-Shuarifi and Al-Zayadi proposes a scheduling method which is again based on the Best-CQI algorithm. The scheduler first collects data about network and channel conditions of the users. Then it separates the users into two groups according their SNR values. And then the algorithm uses the Best-CQI method to allocate resources to both groups according to the priorities of the groups [16].

Soni and Tyagi proposed an algorithm which uses the same classification method with the algorithm defined in [15]. It divides the users into two group, GBR and non-GBR, according to their traffic information. The algorithm tries to maximize the throughput of the non-GBR users who increase the cell spectral efficiency. For allocation, the algorithm uses the metric of the Proportional Fair algorithm and multiplies it with the QCI index parameter to define the priority of the users among them. As with previously defined algorithms, this method also allocates the GBR users first to fulfil their delay constraints. After that, it starts allocation of non-GBR users and provides an opportunistic scheduling to increase the fairness of the system [17].

Wu and Han proposed a Rate-Level-Based scheduling algorithm with the aim of supporting heterogeneous traffic in LTE downlink. The scheduler tries to minimize the packet loss ratio of the real-time traffic while guaranteeing QoS requirements. The algorithm calculates the priority of the users with pending transmissions according to their packet delay budget and HOL (Head of Line) packet delay along with the average spectrum efficiency of each user. After calculation of the priority of the users, the scheduler uses a round robin type process to schedule the users, where it allocates the user with highest priority first and the user with lowers priority the last [18].

Jiang and Zhang propose an algorithm to enhance the capacity of the network. It tries to allocate more resources to the users with poor channel conditions while supporting QoS requirements of the users with good channel conditions. For the users with good channel conditions, the algorithm allocates only the RBs with the instant throughput rate close to the peak rate to them, restricting the number of allocated RBs. This allows the algorithm to preserve more RBs to the users with bad channel conditions [19].

Wang and Huang have proposed another classification based algorithm. However, instead of having two groups of users, they divide the users into three groups which are GBR, non-GBR and Urgent. Urgent queue is given with the highest priority. If the RBs are allocated to all of the UEs in the Urgent queue, then scheduler starts allocation of the second priority group, which is the GBR users. After the allocation process of Urgent and GBR users, non-GBR users are allocated if there is still empty RBs awaiting to be allocated in the system [20].

In network literature, there has been proposed some workaround about QoS since 1990s. One of these frameworks is the Differentiated Services (DiffServ) model proposed by Internet Engineering Task Force (IETF) [21]. In DiffServ, instead of performing flow-based resource scheduling, user packets are classified and marked in the domain [22]. The related work dealing with QoS which are mentioned above use the same logic with the DiffServ model.

On the other hand, the Integrated Services (IntServ) model uses flow-based approach for resource scheduling to provide QoS for individual streams [23]. To support IntServ, two features are necessary; the user application's packet and delay requirements and mechanisms to control the QoS delivered to these users. Instead of classifying users into groups, our algorithm uses a flow-based QoS mechanism as in IntServ to deal with QoS requirements of the users, which will be explained in detail in section 4.6. Table 1.4 shows the comparison of algorithms described in the above section.

Related Work	Algorithms	Number of Users	Mobility	Antenna Config.	CF	Performance Metric
Sun, Z. [6]	PS, PF, SC-PF	20	N/A	1x1	SF	CT, MT
Toseef, U. [7]	BET, PF, Adp. Fair, RR	10	Static	1x1	SF	MT
Sudheep, S. [8]	PET, BET, PF, BCQI, RR	10	Static	2x2	SF	MT
AlQahtani, S. [9]	PS, RR, BCQI	10 - 50	N/A	1x1	SF	CT, Fairness
Bin, L. [11]	EXP-RULE, EXP/PF, LOG-RULE, M-LWDF, M-EDF-PF	10 - 80	N/A	1x1	SF	CT, Fairness, PLR
Trabelsi, S. [12]	LWDF, RR, EDF, PF, M-LWDF, FIFO	10 - 250	N/A	1x1	SF	CT, Avg. Delay, PLR
Akyildiz, H. [13]	BCQI	80 - 150	5km/h	1x1	SF	CT, Avg. Delay
Zaki, Y. [14]	LTE MAC	5, 20, 40	N/A	1x1	SF	CT, Avg. Delay, Response Time
Soni, K. [17]	Optimal, VToD, Sub-Optimal (proposed in [17])	10 - 100	N/A	1x1	SF	CT, Fairness, Complexity
Wu, X. [18]	EXP/PF, MLWDF, ZBQoS, RLBS	5 - 60	3km/h	1x1	SF	Avg. TP, Delay, PLR
Jiang, Z. [19]	M-LWDF, EXP/PF,	5 - 25	N/A	1x1	SF	PLR
Wang, Y. [20]	BCQI, M-LWDF, QFS	10 - 60	N/A	1x1	SF	Avg. TP, Delay, PLR
Proposed Algorithm	PS, PF, BCQI, RR, CoMP RR	20, 40, 60, 80, 100	5, 50, 100km/h	1x1, 2x2, 4x4	MF	ET, PT, CT, Fairness, QoS Fairness

Table 1.4 Comparison of the Related Work

## **1.4 Outline of Thesis**

The remainder of the thesis is composed as follows:

In Chapter 2, LTE will be disclosed including extended features after its release by 3GPP. Moreover, LTE-A/4G will be explained in particular as it is being used in Turkey since 2016, April.

In Chapter 3, physical layer and especially MAC layer of the LTE downlink will be covered where scheduling process takes place. Some of the important notions like OFDM, Frame Structure, Resource Grid, Encoding and Modulation will be explained.

Chapter 4 is the division where the essentials of downlink scheduling system will be revealed. Moreover, some of the most preminent scheduling algorithms in the literature like Round Robin, Blind Equal Throughput, Proportional Fair, and Best CQI will be recounted. Furthermore, the novel algorithm proposed by us will be delineated.

In Chapter 5, LTE System Level Simulator will be described shortly, and simulation scenarios and parameters will be depicted.

Chapter 6 is the part containing results of disparate simulations executed under various scenarios with different scheduling algorithms. Lastly, these simulation results will be figured out and the thesis will be consummated in Chapter 7.

# Chapter 2

## 2. Long Term Evolution (LTE) / 4G

From the time of the inauguration of 1<sup>st</sup> Generation Mobile Telecommunication Systems in the early 1980s, the aim of the usage of mobile devices have changed rapidly with addition of new applications and new services to the market. A variety of these new services like video/music streaming, VoIP, online gaming etc. has yielded the need of guaranteed delay constraints and rapid traffic flow. The reason underneath the development of LTE is to fulfil the demand for this high bandwidth request of mobile services, as well as putting a network infrastructure forward which will be maintainable and sustainable in long term.

LTE has been presented by 3GPP in year 2008 in Long Term Evolution Release 8. Some of the motivations beneath development of LTE are as follows [24]:

- i. Need to ensure the continuity of competitiveness of the 3G system for the future.
- ii. User demand for high data rates and QoS.
- iii. Packet Switch optimized system
- iv. Continued demand for cost reduction
- v. Low complexity
- vi. Avoid unnecessary fragmentation of technologies for paired and unpaired band operation.

### 2.1 Aspects of LTE

Evolved Universal Terrestrial Access Network (E-UTRAN) is the connection member of the Evolved Packet System (EPS). Essential necessities of this new

connection network are high spectral efficiency, high data transfer rates, and low delay times.

Global System for Mobile Communications (GSM) carried out services in a circuit switched system which allowed only low data rates. The initial action starting an IP based packet switched network was taken with the evolution from GSM to GPRS using Time Division Multiple Access (TDMA). To achieve higher data transfer rates in Universal Mobile Terrestrial System (UMTS), a new access method Wideband Code Division Multiple Access (WCDMA) was developed. It works as a circuit switched network for real time services while it turns into a packet switched network when a data service is started. Thus, the data services yet rely on the circuit switched network technology.

One of the most important aspects of EPS is that it is merely based on IP system. When a mobile device (User Equipment, UE) is switched on, an IP address is allocated and it is not released until the UE is turned off. Hence, both realtime services and data services are executed by the IP protocol. LTE uses OFDMA in association with high order modulation schemes and high bandwidths which allows to achieve high data transfer rates. Highest expected data rate on downlink is 300Mbps if supported with a 4×4 spatial multiplexing.

For modulation and encoding schemes LTE employs Adaptive Modulation and Coding (AMC). It is a powerful technology that can alter the scheme according to changing channel conditions. This helps escalate system throughput even with poor channel conditions because modulation can be increased or decreased with respect to the instantaneous channel qualities.

LTE is optimized for mobility especially for pedestrian speeds below 15 km/h. Up to 120 km/h, it can still maintain good connection performances, and a connection can be sustained up to 350 km/h speed.

## 2.2 Architecture of LTE

The abstract architecture of the LTE network consists of three basic components. These are;

- i. The User Equipment (UE)
- ii. The Evolved UMTS Terrestrial Radio Access Network (E-UTRAN)
- iii. The Evolved Packet Core (EPC – Core Network)

The high level architecture can be viewed in Figure 2.1.

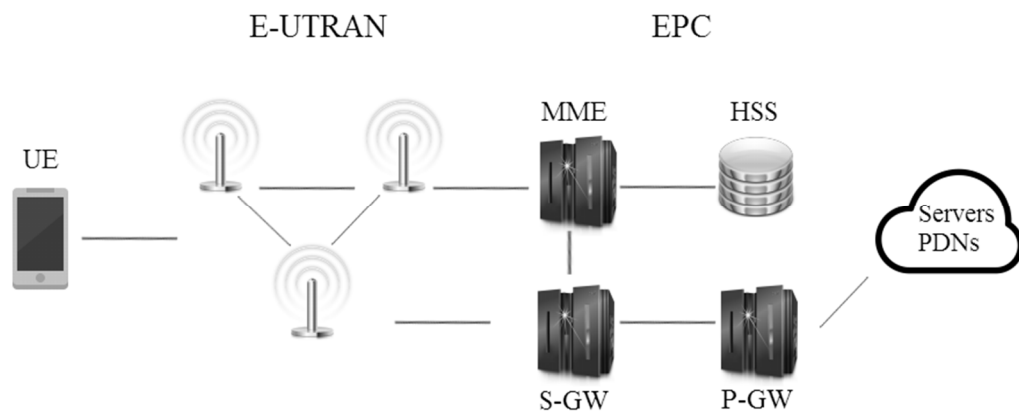

Figure 2.1 High-level LTE Architecture

### 2.2.1 The User Equipment

In UMTS and LTE, User Equipment (UE) is any device that is used directly by an end-user to communicate with the network. It can be a mobile phone, a computer rigged with a mobile broadband adapter, or any other device with mobile connectivity like tablets, cameras etc.

The inner design of the UE is similar to the Mobile Equipment (ME) used with GSM or UMTS. It is composed of three elements. Mobile Termination (MT) controls all of the communication functions. Terminal Equipment concludes data flows. Lastly, Universal Integrated Circuit Card (UICC), which is commonly identified as a SIM card executes an application named Universal Subscriber

Identity Module (USIM). USIM saves user data similar to a 3G SIM card such as user's phone number, network identity, and security keys [25].

### **2.2.2 The Radio Access Network (E-UTRAN)**

LTE's Radio Access Network is called Evolved Universal Terrestrial Radio Access Network (E-UTRAN). It is the module which controls all of the radio communications between the UE and the EPC. It is made up of only one element, the evolved radio base stations, that are shortly called eNodeB or eNB. eNodeBs also communicate with each other via X2 interface. Main function of X2 is extending the entrusting operation between eNodeBs.

E-UTRAN has four important operations to accomplish. These functions are Radio Resource Management (RRM), compressing headers, encrypting and decrypting data, and interchanging data with the EPC.

RRM is a collection of operations including scheduling, link adaptation, handover and Inter-Cell Interference Coordination (ICIC). It manages allocation and lending of resources to the UEs to fulfil their QoS requirements which is called scheduling. Moreover, a UE communicates with only one eNodeB (and one cell) at a time. If there is a need to change a cell for a UE (because of mobility or atrocious channel conditions etc.), a handover procedure is executed by RRM between two eNodeBs over the X2 interface.

In mobile applications, the overhead of a packet is 40 bytes for IPv4 and 60 Bytes for IPv6. This is roughly 60% of the total amount of data sent during a VoIP or gaming service. Such a great overhead is exorbitant for mobile networks where bandwidth is scant. To prevail this problem, the large overhead is compressed into a few bytes before transmitting, and a decompressor performs the opposite to recover the original overhead at the other end.

E-UTRAN is responsible to assure the security of the data transmitted over the air interface. For this purpose, data is encrypted in the transmitter and decrypted at the receiver. The encrypted data is meaningless to anyone who may intrude and listen to the channel illegally. Hence privacy of the data can be maintained this way.

Interchanging data with the EPC is executed via two interfaces, S1-MME and S1-U which will be covered in the next part.

### **2.2.3 The Core Network (EPC)**

In the design phase of LTE, 3GPP agreed to choose a flat architecture and adopt Internet Protocol (IP) as the decisive protocol to transport all services. Therefore, EPC would not have a circuit-switched interface and it would be an evolution of the packet-switched architecture used in GPRS and UMTS. Not too many network nodes are included in the spine to avert protocol switching. EPC architecture consists of the following logical elements: Home Subscriber Server (HSS), Serving Gateway (S-GW), Packet Data Network Gateway (PDN-GW), and Mobile Management Entity (MME) [11].

HSS is a database that keeps user data and subscriber data. Moreover, it supports mobility management, session and call setup, user authentication and access authorization with built-in functions.

S-GW and PDN-GW deal with user plane. They exchange the IP data flow between the UE and the external network or internet. The Serving Gateway is the interconnecting node between E-UTRAN and the EPC. It serves the UEs by transmitting incoming and outgoing IP data packets between the interfaces. It is the anchor point for mobility (i.e. if there is a need of handover) both intra LTE and between LTE and former 3GPP networks like GSM/GPRS and HSPA. It is connected to PDN-GW logically.

PDN-GW is the connection point of EPC and external networks which are called Packet Data Networks. It transmits and receives packets to and from the PDNs. It also performs a variety of functions like IP address allocation and policy control. Moreover, it is the mobility anchor point for non-3GPP technologies like WiMAX and CDMA2000. These gateways are specified separately by 3GPP but they can be combined in practice.

MME is responsible for the control plane, it controls the signaling operations related to mobility and security between UE and EPC. Moreover, it is responsible for tracking and paging of idle UEs, connecting and releasing of carriers between EPC and UE. It is the end point of the Non-Access Stratum (NAS).

## **2.3 LTE-A**

The main objective of LTE-Advanced technology is to increase the overall capacity of LTE. The motivation of further developing LTE to LTE-A Release 10 is to maintain higher bandwidth through decreased costs, and concurrently fulfil whole requirements determined by International Telecommunication Union (ITU) for IMT Advanced technology [26].

LTE-A added on some new aspects and new functions. With LTE-A, theoretical peak data rates are 3Gbps for downlink and 1.5Gbps for uplink, and performance of the network is upgraded especially at the cell edges. Next, LTE-A comes up with a higher spectral efficiency than LTE with a 30bps/Hz against 16bps/Hz, and increases the maximum number of active users connected simultaneously.

The main functionalities that come along with LTE-A are Carrier Aggregation (CA), extended usage of multi-antenna technologies, Relay Nodes (RN) support and Coordinated Multi Point operation (CoMP).

### 2.3.1 Carrier Aggregation

A very simple way of raising system capacity is adding more bandwidth. This raise in LTE-A is implemented by combining carriers, which can be used both in Frequency Division Duplexing (FDD) and Time Division Duplexing (TDD). Carrier Aggregation chiefly shapes MAC and physical layer protocol.

Every combined carrier is identified as a component carrier. A component carrier can have one of the bandwidths of 1.4, 3, 5, 10, 15 or 20Mhz, and at most five component carriers can be combined at the same time, which results with a maximum bandwidth of 100Mhz. Number of the combined carriers might be different for downlink and uplink, but number of uplink component carriers can never be greater than number of downlink component carriers. Figure 2.2 shows an illustration of carrier aggregation operation.

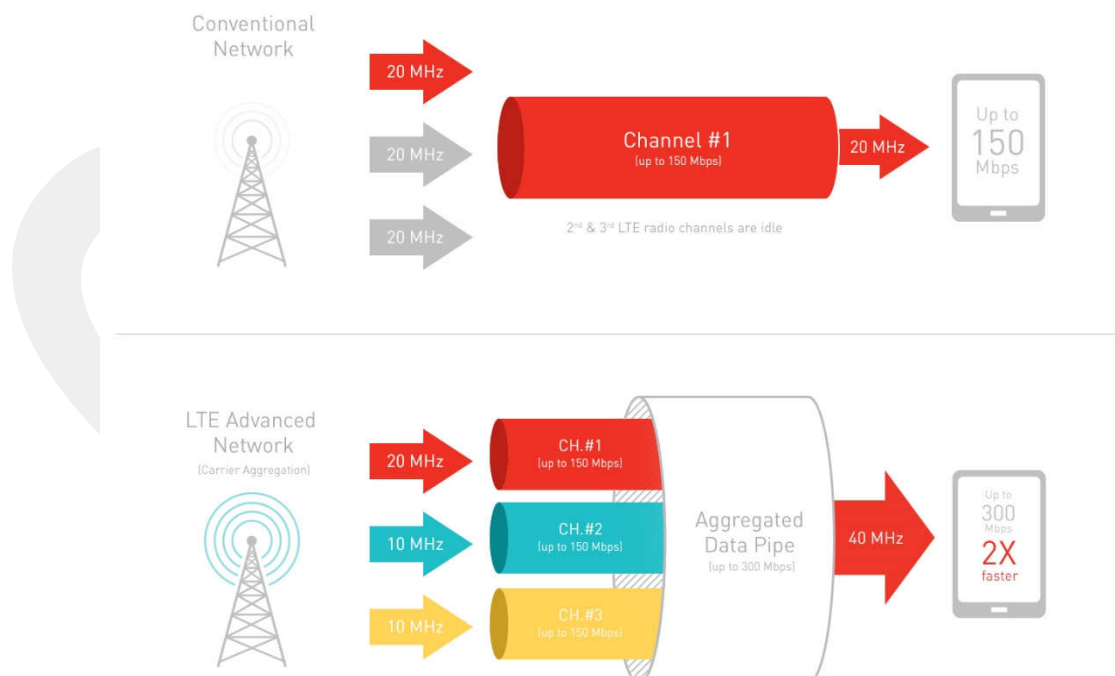

Figure 2.2 Carrier Aggregation [27]

Easiest way of combining carriers is to employ adjacent carriers inside the same frequency band (intra-band). If this is not feasible for any reason at a time, non-adjacent carriers can also be combined either intra-band or inter-band where the component carriers belong to different operating frequency bands.

### 2.3.2 Multiple Input Multiple Output (MIMO)

Multiple Input Multiple Output is a technique that is used to upgrade the system throughput by using two or more antennas for transmitting two or more distinct data flows, to be received by two or more antennas. Figure 2.3 illustrates a 2x2 MIMO antenna configuration. MIMO uses same resources in both time and frequency domain which are differentiated by using distinct reference signals. The radical change coming with LTE-A is the support of 8x8 MIMO in downlink and 4x4 MIMO in uplink transmissions.

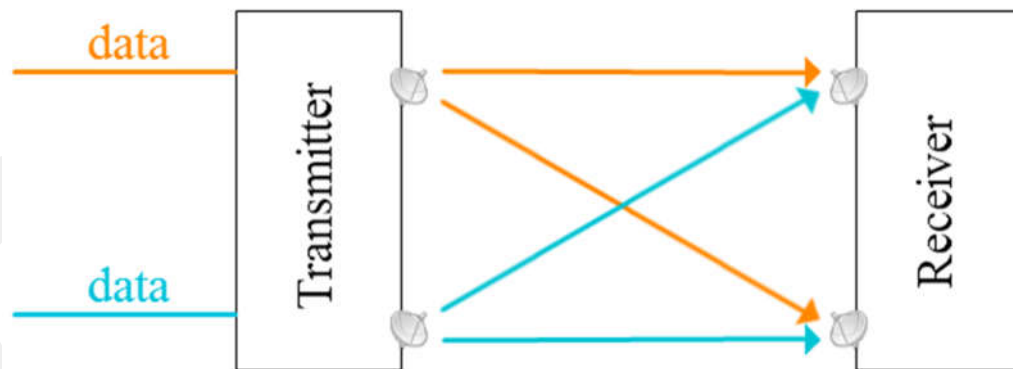

Figure 2.3 A 2x2 MIMO

A better practice is to use MIMO when the channel conditions are good and Signal to Noise Ratio (SNR) is high. However, if the channel conditions are poor, it is more preferable to use other techniques like transmit diversity to increase probability of delivery of data, where two or more independent bearers with different channel characteristics carry exactly the same information at an instant. In MIMO, there is a precoding process to assign the modulation symbols onto different antennas. The precoding operation is executed according to the MIMO

technique used along with the number of layers and antenna ports. The target of precoding is to obtain the best available data reception at the receiver side. During transmission, the radio signal can experience interference by fading of various types. To outreach this issue, accepted reference signals are transmitted along with the precoded data, and they are used by the receiver for demodulating the received signal and recovering the original data.

### 2.3.3 Relay Nodes

One of the improvements come along with LTE-A is Relay Nodes (RN), which allows the combination of small and large cells together aptly. A Relay Node is a base station that consumes low energy designed to extend the coverage and throughput at the cell edges or hot spots.

An RN connects to a Donor eNodeB (DeNB) through a radio interface, consequently radio resources in a Donor cell are distributed to RNs as well as directly served UEs. Figure 2.4 depicts an organization of a RN and a DeNB inside a cell.

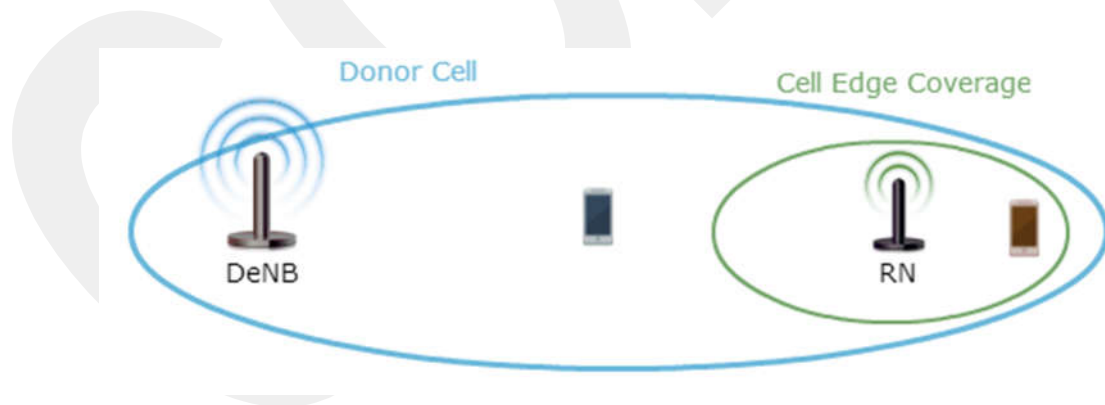

**Figure 2.4 Relay Node**

If a RN and DeNB are employing same frequencies, there occurs a peril for self-interference in the RN if receiving from an UE and transmitting to the DeNB simultaneously. The way to avoid this risk is time sharing between transmission and reception process, or putting transmitter and receiver to separate places. An

RN is supposed to maintain same features as the eNodeB, but eNodeB still will be responsible for choice of MME.

### 2.3.4 Coordinated Multi Point Operation

The major aim of 3GPP introducing CoMP in LTE-A is to upgrade the performance of the cell at the edges. In CoMP, an amount of transmitters arranges coordinated transmission in the downlink, and an amount of receivers provide coordinated reception in the uplink.

CoMP is a combination of distinct methods that endorse coordination of transmission and reception dynamically over different eNodeBs. Its aim is to upgrade overall throughput for UE, particularly at the cell edges. Moreover, when a UE is connected to multiple eNodeBs, its data can be transmitted through the least busy eNodeB, or through the best quality channel among the connections which is expected to decrease delivery delays and increase capacity. A sample CoMP topology is shown in Figure 2.5.

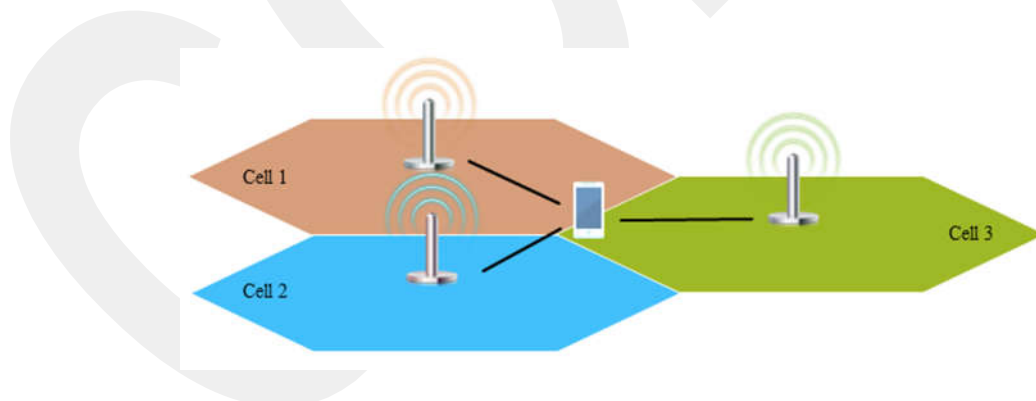

Figure 2.5 Coordinated Multi Point

CoMP also compels tight coordination between an amount of eNodeBs that are distributed in a topology. The eNodeBs have to coordinate continuously to maintain joint scheduling and dispose the received data from the UE. Thence, a UE close to cell edge can experience better network conditions being served by multiple eNodeBs.

# Chapter 3

## 3. LTE Downlink Physical Layer

LTE Physical Layer (PHY) architecture settles the most common demand in mobile networks, high transmission rates and spectral efficiency, in the first place. To conform this demand, Orthogonal Frequency Division Multiplexing (OFDM) was employed for downlink physical layer. Along with OFDM, LTE uses MIMO to upgrade channel capacity. OFDM and MIMO are the pivotal technologies used in LTE and they establish the main improvement over 3G that employs Code Division Multiple Access (CDMA) [28].

### 3.1 Orthogonal Frequency Division Multiplexing

Orthogonal Frequency Division Multiplexing was first introduced in the 60s. It was contemplated to be used in 3G network in the 90s, however it was waived after figuring out that it was crude at that time. Advancements in electronic engineering and signal processing areas after that time has developed OFDM as a sophisticated technology and it was extensively used in wireless network systems like Wi-Fi and WiMAX and transmission systems (Digital Audio/Video Broadcast – DAB/DVB).

OFDM is a multi-carrier modulation and transmission scheme. Dissimilar to single-carrier systems, OFDM is not based on increased symbol rates to be able to reach high transmission rates. It breaks the vacant bandwidth into several smaller subcarriers and transfers the data through these subcarriers in parallel flows which allows high spectral efficiency and throughput. A very important advantage of OFDM is its vigor against frequency selective fading. In a single carrier network, a link can fail to transfer data, oppositely the parallel structure of multi carriers allows to cope with this problem as only a few subcarriers might fail due to frequency selective fading.

If a modulation is assigned to a carrier, its sidebands extend to its both sides. In order to demodulate the transmitted data completely, a receiver has to receive all of the signal. Thus, signals that are transmitted close to each other must be separated sufficiently so that the receiver can split the signals via a filter. OFDM overcomes this issue as its subcarriers are orthogonal to each other, that is, the carrier distance is equal to the complementary of the symbol period. By this aspect, each subcarrier has all of the cycles in a symbol period and their aggregation becomes zero, which means there is no interference contribution between the subcarriers. This contributes to spectral efficiency by evading guard bands and allowing the subcarriers to be placed closer to each other. Figure 3.1 depicts an example of subcarriers of OFDM in time and frequency domains.

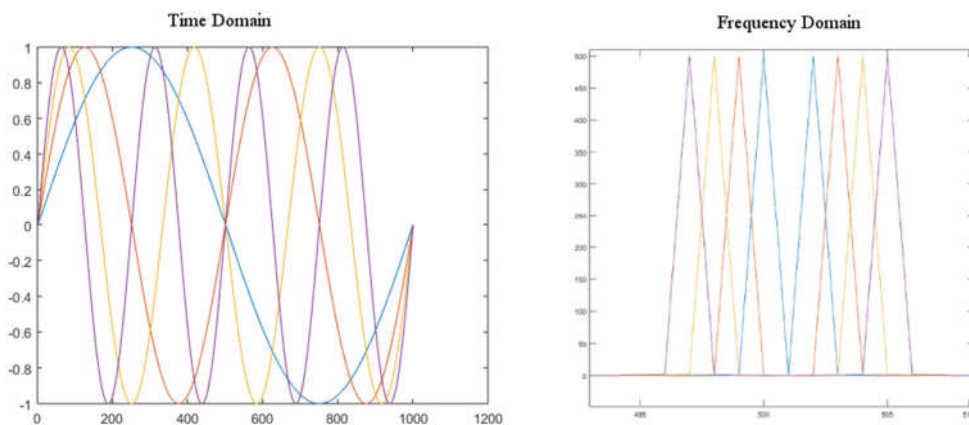

**Figure 3.1 Example of four subcarriers in time and frequency domains.**

In OFDM, symbols can be modulated via different modulation schemes such as QPSK (4QAM), 16QAM, 64QAM (and 256QAM introduced in LTE-A). Modulation and demodulation of OFDM signals need resolving a large number of sinusoidal signals for every subcarrier, which is computationally very complex. Fortunately, an OFDM signal can be acquired by evaluating the real part of the complex value coming from the inverse discrete Fourier transform (IDFT) of the original signal. IDFT of a signal can be evaluated using a computationally simpler algorithm, Fast Fourier Transform, which reduces the complexity of calculations.

Demodulation operation completes successfully if there does not exist an Inter-Symbol Interference (ISI) on the admitted signal. Multipath delays can cause ISI between OFDM which might induce data loss on the transmitted signal. The Cyclic Prefix (CP) concept was introduced for reliability against ISI. CP acts as a guard band between OFDM symbols; each OFDM symbol is guided by a definite part of the end side of the own symbol. CP reduces ISI and provides robustness to the system, however since it retransmits some part of the data, it reduces system capacity and overall throughput performance [29].

Orthogonal Frequency Division Multiple Access (OFDMA) can be declared as the multi-user scheme derived from OFDM. In OFDMA, multiple access is attained by allocating divisions of subcarriers to multiple users simultaneously resulting with a multi-user scheme.

## 3.2 Frame Structure

LTE Downlink Frame Structure consists of downlink channels and signals. The LTE frame can be thought as an abstract grid with time and frequency as the axes. E-UTRAN supports two types of frame structures, Type-1 for Frequency Division Duplexing and Type-2 for Time Division Duplexing. Different time intervals in the frame are asserted as products of an elemental time unit  $T_e = 1/30720000$ . The length of one frame is 10ms;  $T_{\text{frame}} = 307200 \times T_e$ .

In Type-1 structure, every frame is partitioned into ten identical subframes each having 1ms length;  $T_{\text{subframe}} = 30720 \times T_e$ . Scheduling is executed based on a subframe. Every subframe also contains two identical slots with 0.5ms length;  $T_{\text{slot}} = 15360 \times T_e$ , and each slot contains a number of OFDM symbols, which can either be seven with normal CP or six with extended CP [14]. Figure 3.2 delineates Type-1 frame structure.

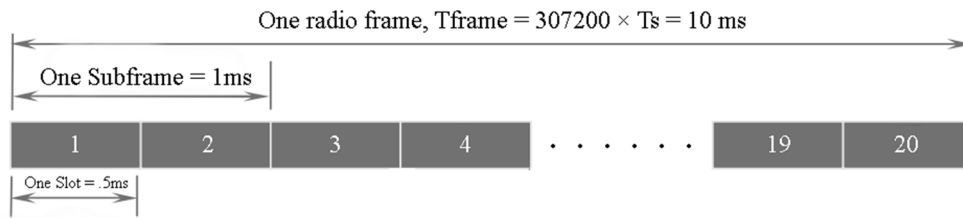

**Figure 3.2 Type-1 Frame Structure**

In Type-2 structure, one frame is divided into two equal half-frames,  $T_{\text{half-frame}} = 153600 \times T_e$ . Every half-frame is then divided into five equal subframes containing two slots with 0.5ms length each.

### 3.3 Resource Grid

Resource grid delineates physical resources of LTE. The physical resource in each slot is represented by a time-frequency grid. Every row and every column in the grid forms one OFDM subcarrier and one OFDM symbol. Length of the resource grid in time domain represents one slot in a radio frame.

The shortest time-frequency entity in the grid is named a Resource Element (RE). An RE contains twelve subcarriers with seven or six OFDM symbols with normal CP or extended CP respectively [30]. The resource grid contains a huge amount of REs; this amount is decided by the bandwidth which is defined on eNodeB. The smallest entity that can be allotted to a UE is called a Resource Block (RB). A RB contains several REs, corresponding to an amount of symbols multiplied by subcarriers according to the bandwidth of the network. For 1.4 MHz channel bandwidth, number of RBs is six, while it is a hundred for 20 MHz bandwidth. Figure 3.3 delineates an abstract resource grid.

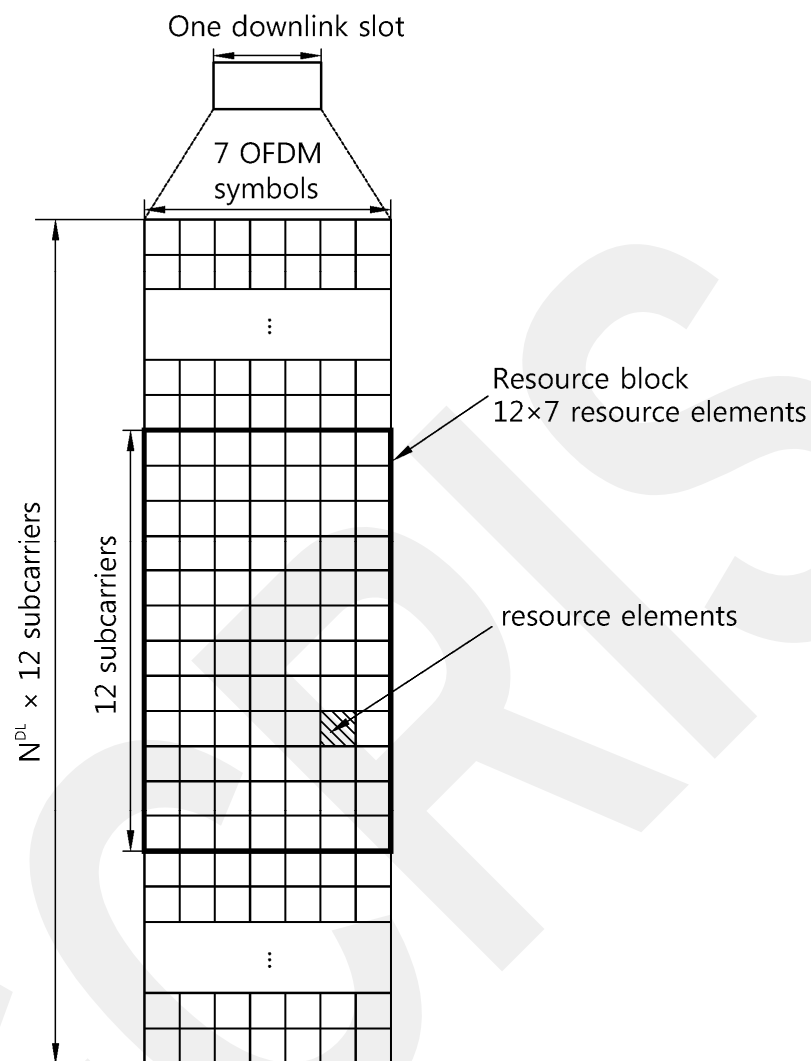

**Figure 3.3 LTE Resource Grid [31]**

Spacing of the subcarriers can be either 7.5 KHz or 15 KHz. Regularly, 15 KHz spacing is used, except for the Multicast Broadcast Single Frequency Network (MBSFN). MBSFN uses 7.5 KHz spacing with extended CP. Table 3.1 contains subcarrier spacing information with Normal CP and Extended CP.

	Spacing	# of Subcarriers	# of OFDM symbols
Normal CP	15 KHz	12	7
Extended CP	15 KHz	12	6
	7.5 KHz	24	3

**Table 3.1 Subcarrier Spacing**

### 3.4 Channel Coding

Channel Coding is an important feature utilized in digital telecommunication systems, which allows error detection and correction for the transmitted signals. For error detection and correction, rate adaptation and interleaving methods are used in LTE channel coding. Two error correction methods are present with LTE; Automatic Repeat Request (ARQ) and Forward Error Correction (FEC). In ARQ method, the receiver petitions resending of the erroneous packets if any errors are detected by an error detection tool, until errorless packet is received or a peak number of resends are reached. In FEC method, data is added with redundancy bits either by block coding or convolution, and LTE also uses an extended coding method named Turbo Code, which has a performance close to the Shannon capacity. Using the redundancy bits, errors in the data can be amended [32].

A convolutional encoder contains an m-staged shift register; its outputs are added with XOR to build the output bit. For k bits of data input, the encoder results n bits output. Rate of the code is thus  $R=k/n$ . Figure 3.4 demonstrates a convolutional encoder with  $k=1$ ,  $n=3$  and  $m=6$ .

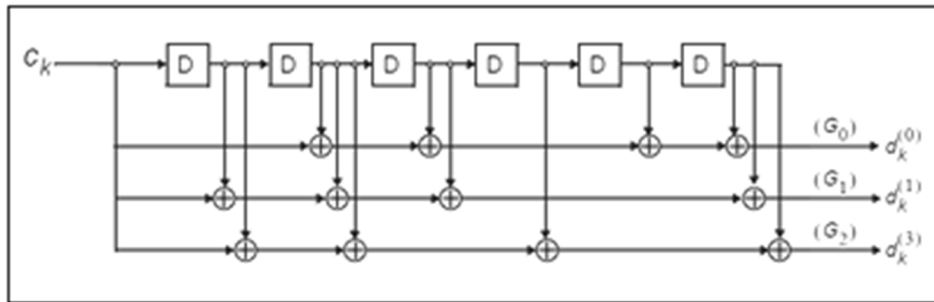

Figure 3.4 Convolutional Encoder with  $k=1, n=3, m=6$  [33]

Turbo Encoder of LTE is a Parallel Concatenated Convolutional Code (PCCC) scheme containing two 8-state constituent encoders and an internal turbo code interleaver with  $R = 1/3$ . Figure 3.5 depicts the structure of LTE Turbo Encoder.

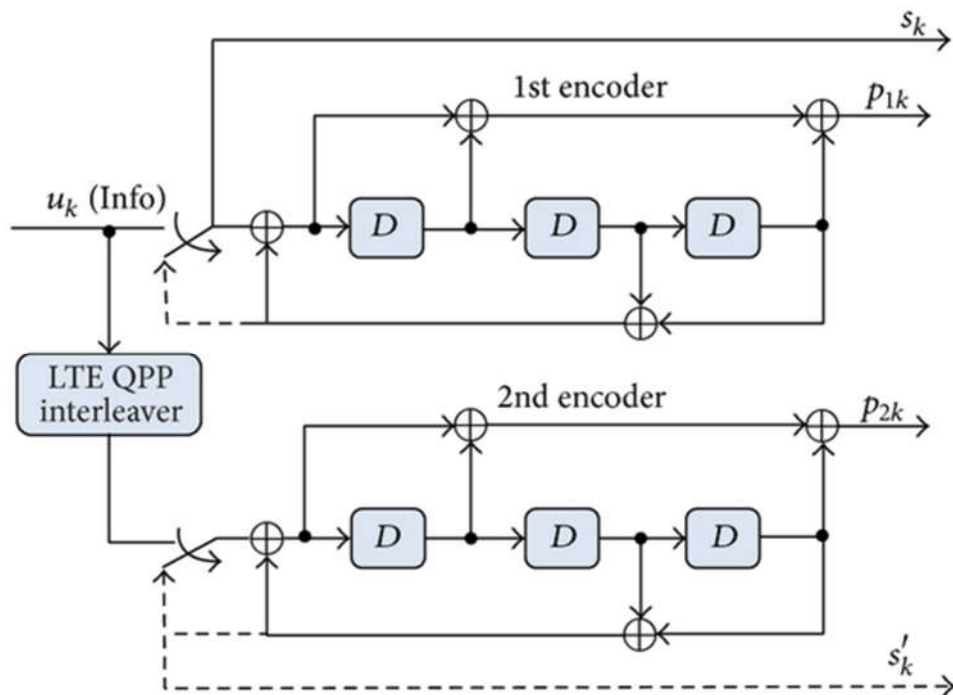

Figure 3.5 LTE Turbo Encoder Structure [34]

Turbo encoder output consists of three parts; one systematic bit and two parity bits. Systematic bit is the intact input bit. First parity bit is the output of the first

convolutional encoder and second parity bit is the output of the second convolutional encoder.

### **3.5 Link Adaptation**

Link Adaptation is a method used to modify the encoding and modulation scheme in accordance with the channel quality. In LTE, link adaptation is built on the Adaptive Modulation and Coding (AMC) method.

AMC conforms modulation scheme according to Signal to Interference plus Noise Ratio (SINR) of the channel. If SINR is large enough, high order modulation schemes offering higher spectral efficiencies are used (64QAM for LTE, and 256QAM for LTE-A). Oppositely, when the channel state is poor and the SINR is low, a low order modulation scheme like QPSK or 16QAM is employed, which are stronger against errors but with lower spectral efficiency.

For a defined modulation scheme, AMC again selects the suitable code rate according to the channel quality. Higher channel quality yields higher code rates and thus higher data rate.

CQI	Modulation (LTE)	Modulation (LTE-A)	Code rate (x 1024)	Spectral Eff. (LTE)	Spectral Eff. (LTE - A)
0	Out of range				
1	QPSK	QPSK	78	0.1523	0.1523
2	QPSK	QPSK	120	0.2344	0.3770
3	QPSK	QPSK	193	0.3770	0.8770
4	QPSK	16QAM	308	0.6016	1.4766
5	QPSK	16QAM	449	0.8770	1.9141
6	QPSK	16QAM	602	1.1758	2.4063
7	16QAM	64QAM	378	1.4766	2.7305
8	16QAM	64QAM	490	1.9141	3.3223
9	16QAM	64QAM	616	2.4063	3.9023
10	64QAM	64QAM	466	2.7305	4.5234
11	64QAM	64QAM	567	3.3223	5.1152
12	64QAM	256QAM	666	3.9023	5.5547
13	64QAM	256QAM	772	4.5234	6.2266
14	64QAM	256QAM	873	5.1152	6.9141
15	64QAM	256QAM	948	5.5547	7.4063

**Table 3.2 Modulation vs CQI**

In LTE, CQI is the feedback information which echoes the SINR and the channel conditions sent to eNodeB by the UE. It is used to depict the available data rate through the channel. Table 3.2 shows the CQI indexes, modulation schemes, and code rates for LTE and LTE-A.

# Chapter 4

## 4. Scheduling

The Scheduling process is a very important phase of Radio Resource Management (RRM) operation in LTE. Scheduling roughly is lending radio Resource Blocks (RBs) to user equipments (UEs), who are connected to an eNodeB in an LTE cell in every Transmission Time Interval (TTI) repeatedly. In LTE, the eNodeB is the component where Scheduling takes place both for downlink and uplink. The OFDMA multiple access technique employed in LTE allows to perform scheduling both in time domain (TD) and frequency domain (FD).

Primary goal of the Scheduler is to serve the UEs fairly while trying to keep the cell throughput at the peak level. 3GPP has not defined a standard for Scheduling algorithms, instead mobile operators or mobile component producers decide which algorithm will be used for scheduling. It is important to select the most convenient scheduling algorithm for gaining best desired performance.

Every UE creates a channel state report called Channel State Information (CSI) according to the channel conditions of the RB it is assigned, and is answerable for sending this information to the eNodeB every TTI. Scheduler can use the CSI to allocate the RBs to the UEs, since it is conceivable to alter transmission parameters according to instant channel conditions, which is essential for setting up a robust communication with high data rates. Figure 4.1 depicts the CSI and Scheduler diagram between UE and eNodeB. UE sends CSI to eNodeB and scheduler shall decide allocation of resources according to CSI. After scheduling process, eNodeB makes a precoding and transmits the data to the UE.

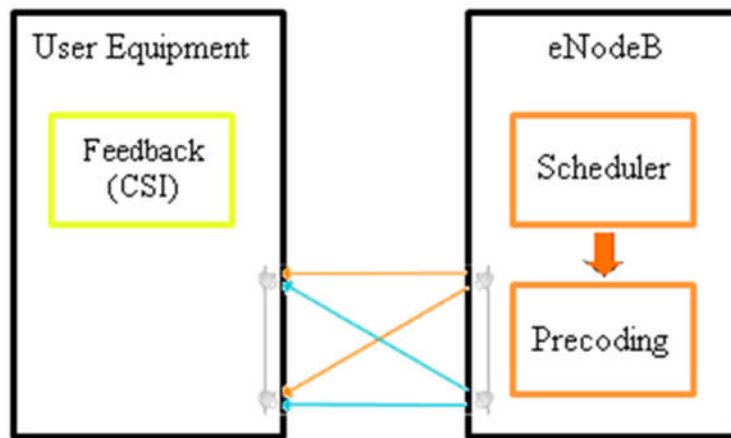
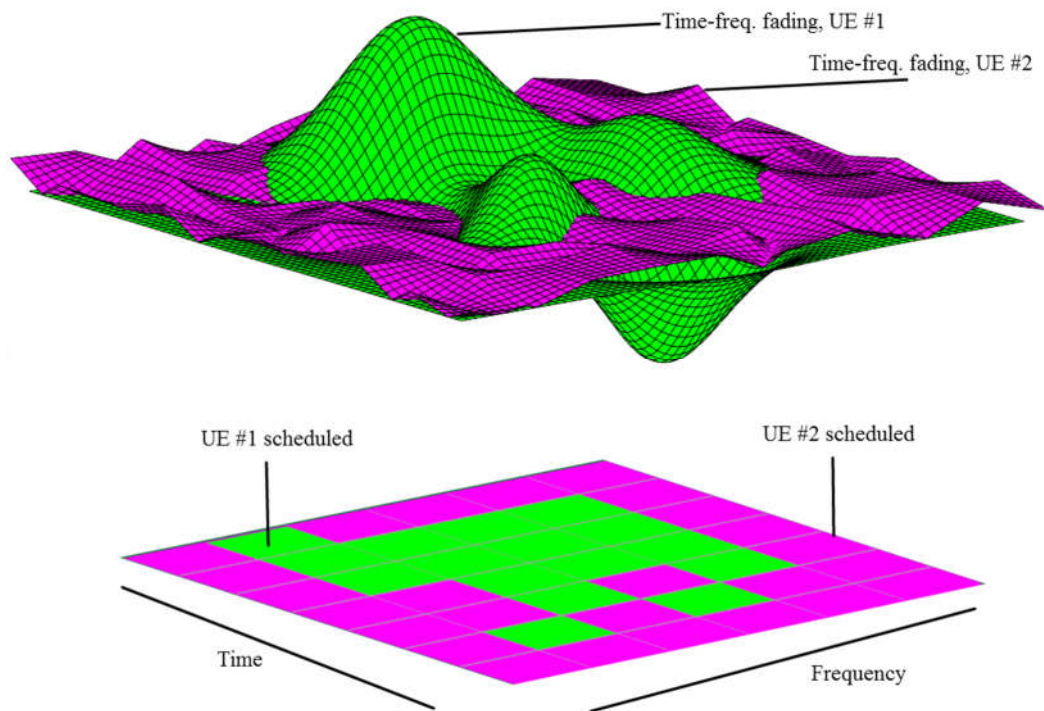

Figure 4.1 CSI – Scheduler diagram

## 4.1 Types of Scheduling Algorithms

Fundamentally there are two type of Scheduling methods for Radio Resource Management (RRM) in the LTE network. These two types of scheduling methods are channel state blind algorithms and channel state aware algorithms. Channel-blind algorithms do not care about the CSI or CQI while scheduling. This type is not very adequate for mobile wireless systems since channel conditions may vary rapidly due to frequency selective fading or other channel variables. As a natural outcome of these algorithms, a UE can be allocated an RB even the channel condition is poor, which causes decrease in the overall system throughput even though the allocation might seem fair. Figure 4.2 describes a scheduling according to the channel quality of the UEs. To increase overall cell throughput, it can be logical to allocate users who have good channel qualities for an RB.

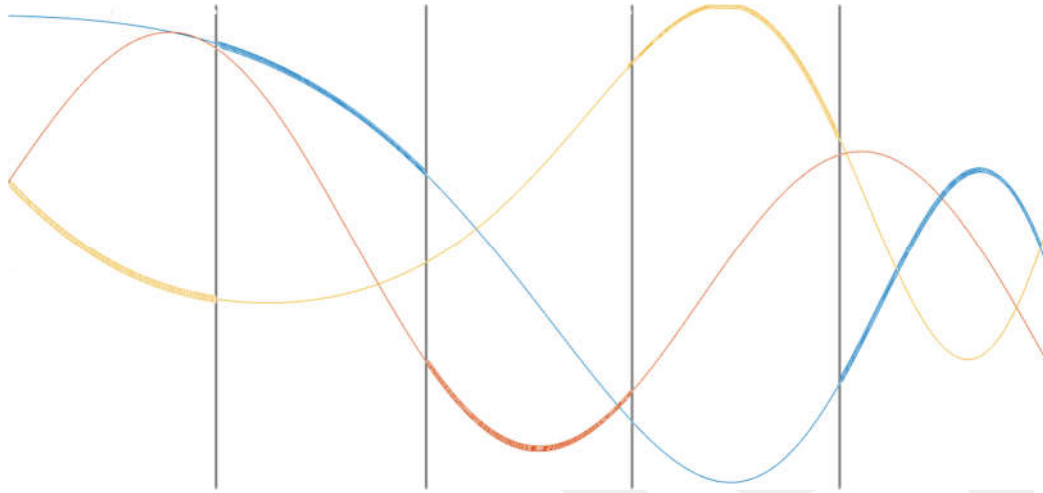

**Figure 4.2 Channel-aware Scheduling**

Adversely, channel-aware algorithms can be used to share RBs among the UEs more efficiently by controlling their channel conditions and lending RBs to the UEs with better channel quality. For this purpose, the CQI feedback coming from the UEs for each RB is used. This kind of schedulers perform better about maximizing cell throughput, however fairness of the network can be a problem and needs a workaround which will be explained later on in this thesis.

## 4.2 Round Robin Algorithm

Round Robin algorithm is the most famous example of the channel-blind algorithms. It is frequently used in LTE networks since it provides acceptable fairness results and it is easy to implement because it does not perform any calculations during the scheduling process. The algorithm simply lends RBs one by one to the UEs consecutively until all of the users are assigned a resource. After this process, the algorithm starts over from the beginning of the UE list and repeats this sequence in each Transmission Time Interval.



**Figure 4.3 Round Robin Scheduling Example**

Figure 4.3 depicts a sample resource allocation using RR. Since it is channel-blind, it sometimes allots UEs who are on fading channels and this causes decrease in the throughput as a result of bad channel condition. Although RR seems like a fair algorithm, the fairness it provides is in terms of the number of RBs assigned to each UE rather than throughput manner.

### 4.3 Blind Equal Throughput Algorithm

Blind Equal Throughput (BET) algorithm, as its name implies, is an example of channel-blind algorithms. Its aim is to provide fairness in terms of throughput for all UEs connected to the same eNodeB [35]. It uses the throughput values of the UEs reach at each TTI. It saves these throughput values in memory and uses the past values in a metric it predefines to decide the UE to be allotted for a RB. The metric BET defines is;

$$M_i = \frac{1}{\bar{T}_i(t)} \quad (4.1)$$

$\bar{T}_i(t)$  is the average of past throughputs of  $i^{\text{th}}$  UE and is computed as follows;

$$\bar{T}_i(t) = \frac{1}{\alpha} T_i(t) + \left(1 - \frac{1}{\alpha}\right) \bar{T}_i(t-1) \quad (4.2)$$

where  $T_i(t)$  is the momentary throughput value of the UE and  $\alpha$  is the window length. If a UE is not allotted but it is active in a TTI, than its  $T_i(t)$  is taken as 0 for that TTI.

From the equations 4.1 and 4.2, it can be seen that BET algorithm aims to schedule the UEs which have lower average throughput in a past window. That means, UEs having lower average throughput are going to be scheduled until they reach or pass the average throughput of the other UEs connected to the same eNodeB. As a result, UEs facing bad channel quality are allotted more RBs than UEs with good channel quality to maintain a good fairness result in terms of throughput. However, this approach certainly decreases the overall cell throughput which is not a desired outcome.

### **4.3 Max-Min Algorithm**

Max-Min (MM) algorithm is the last example to channel-blind algorithms in this chapter. As name hints, it strives to enlarge smallest throughput of UEs in the same cell [36]. It is obvious that, max-min fairness can be reached by increasing the resources allotted to the UEs with lower throughputs, however this consequently results in decreasing the number of allotted resources to some other UEs.

Trying to maximize a UEs throughput advances the fairness of the network in terms of throughput. Nonetheless, this effort curbs the overall throughput of the network by assigning less RBs to the UEs with good channel quality and more RBs to the UEs with bad channel quality as in the BET algorithm.

### **4.4 Best-CQI Algorithm**

In every TTI, Best-CQI algorithm strives to allocate RBs to the UEs who have the finest channel conditions for each RB [37]. It guarantees the largest throughput for a cell because it always allots a RB to the UE with the best channel quality for

that RB. However, based on the fairness-throughput trade-off, this results in a deficient fairness index for the network.

Best-CQI grants RBs only to the UEs with best channel conditions, oppositely UEs with worse channel conditions, especially the ones close to the cell edges, may never be able to use the network with this scheme. The metric of the algorithm given in (4.3) is rather simple:

$$k = \operatorname{argmax}_j(R_j) \quad (4.3)$$

where  $R_j$  is the momentary transmission rate for  $j^{\text{th}}$  user and it is calculated from the CQI value sent by each UE to the eNodeB.

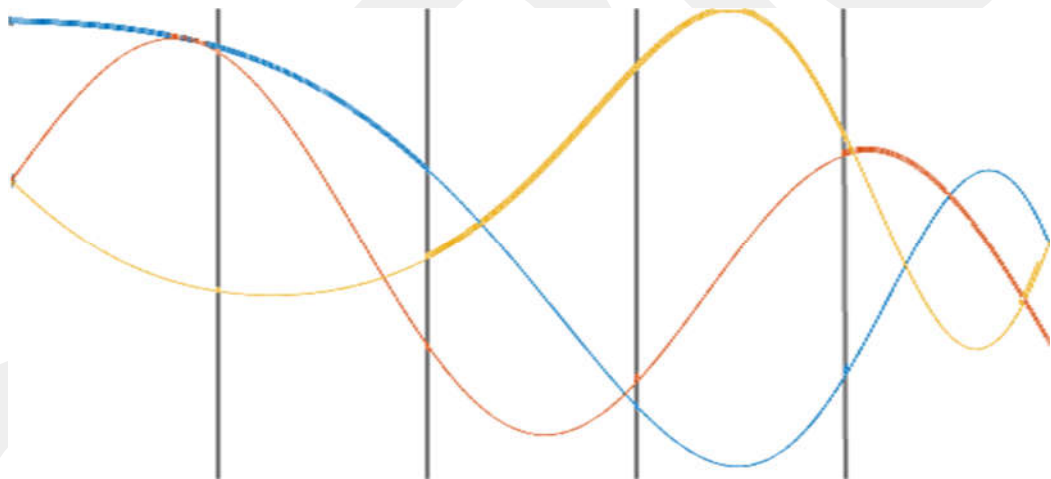

**Figure 4.4 Best-CQI Scheduling Example**

Figure 4.4 illustrates a sample resource allocation with Best-CQI algorithm. It always allots UEs who have the best channel conditions at each TTI and this results in a high overall throughput. Adversely this type of allocation produces an unfair system, peculiarly for the UEs close to the cell edges challenging poor channel conditions.

## 4.5 Proportional Fair Algorithm

The Proportional Fair (PF) algorithm is designed with the aim of maintaining a fair system while averting big cutbacks in the overall system throughput. For this

purpose, it benefits varieties in the channel to extend spectral efficiency. Briefly, if a UE has a good channel quality with a RB when compared to its past average channel conditions, that UE is allotted the RB for the TTI. This process is executed according to a predefined formula which uses the momentary and the past average throughput values of the UEs which are saved in a memory. The formula of the PF algorithm metric is;

$$k(t) = \operatorname{argmax}_{i=1,\dots,N} \left( \frac{R_i(k,t)}{T_i(t)} \right) \quad (4.4)$$

where  $R_i(k, t)$  is the momentary data rate of  $i^{\text{th}}$  user on  $k^{\text{th}}$  RB at time  $t$ , and  $T_i(t)$  is the past average throughput of the  $i^{\text{th}}$  UE. From the formula, it can be seen that a UE can be assigned multiple RBs which can either be contiguous or non-contiguous which is described in Carrier Aggregation (CA) section. At the end of each TTI, the past average throughput of the UE is evaluated as in (4.2).

The PF algorithm is realized in three steps [5]. At the first step, the below code is calculated for each pair of unallotted  $n^{\text{th}}$  RB and  $k^{\text{th}}$  UE;

$$\frac{r_{k,n}}{(\alpha-1)T_k + \sum_{n=1}^N \rho_{k,n} r_{k,n}} \quad (4.5)$$

where  $r_{k,n}$  is the momentary transmission rate of  $k^{\text{th}}$  UE on  $n^{\text{th}}$  RB,  $T_k$  is the average throughput of the same user, and  $\rho_{k,n}$  is whether 1 or 0 meaning the RB is allotted to UE or not. At the second step, UE and RB pairs are picked according to the code below and RB  $n^*$  is allotted to UE  $k^*$ :

$$(k^*, n^*) = \operatorname{argmax}_{k,n} \left( \frac{r_{k,n}}{(\alpha-1)T_k + \sum_{n=1}^N \rho_{k,n} r_{k,n}} \right) \quad (4.6)$$

At the last step, reiterate steps 1 and 2 until all RBs are paired with UEs and update  $T_k$  for each UE when the pairing process ends.

## 4.6 Proposed Algorithm

In mobile networks, users are spread in the covering area of a base station. The quality of communication channel of a user depends on the gap between the user and the station. This affects the SNR, BER, transmission delay and achieved

throughput. As the gap increases, that is, the user is closer to the cell edge, SNR and throughput will decrease while BER and delay will increase.

The Proportional Fair (PF) algorithm disclosed in the previous section allocates network resources to the users according to the following metric:

$$k^*(n) = \operatorname{argmax} \frac{R_k(n)}{T_k(n)} \quad (4.7)$$

where  $R_k(n)$  is the current achievable throughput for the  $k^{\text{th}}$  user on  $n^{\text{th}}$  resource block and  $T_k(n)$  is the average throughput of the  $k^{\text{th}}$  user in a predefined past frame.

The PF algorithm provides very nice results both in terms of fairness and throughput. However, it lacks a mechanism to deal with the QoS needs of the users. QoS means being able to maintain different rank for different transmission requests, that is, to maintain a guaranteed rate of data transmission for different user applications.

For this purpose, we introduce a new fairness metric named QoS fairness. This metric takes delay needs of each user's packets into consideration. The definition of the metric is as follows: If a packet is delivered in time, the fairness index of the user is incremented, else it is increased by the amount of transmitted data divided by the packet size after the end of necessary delay time.

$$f_{k,i} = \begin{cases} 1 & \text{if } B_r = 0 \\ (B_t/P) & \text{if } B_r > 0 \end{cases} \quad (4.8)$$

where  $f_{k,i}$  is the fairness value of  $k^{\text{th}}$  user in  $i^{\text{th}}$  TTI,  $B_r$  is the amount of remaining data bits at the end of requested delay,  $B_t$  is the amount of successfully transmitted data bits, and  $P$  is the packet size. After estimating  $f_{k,i}$  for each user,

its average is calculated to find the eventual fairness  $F$  of the system, where  $N_{UE}$  is the number of users in a cell.

$$F = \frac{\sum_{k=1}^{N_{UE}} f_{k,i}}{N_{UE}} \quad (4.9)$$

The aim of our algorithm is both maintaining good QoS fairness results when compared to other schedulers, and increasing average throughput of edge users without causing a big decrease in overall cell throughput. For this purpose, our algorithm uses the requested delay, instantaneous throughput, packet size, and necessary delivery time of the user in each Transmission Time Interval (TTI).

$$D_k(n) = P / R_k(n) \quad (4.10)$$

The time needed to transmit a packet is  $D_k(n)$  and it is calculated by dividing packet size  $P$  of a user by current achievable throughput  $R_k(n)$  of that user. If  $D_k(n)$  of a user's packet is smaller than requested delay  $Q_k$ , it is better to increase the user's chance of getting resources because the packet has a chance to be delivered in time. Here, we use the metric (4.7) of the PF algorithm, but we temporarily modify the CQI feedback input of the user by adding or subtracting it with a coefficient  $c$ , where  $c$  can be modified during scheduling process to reach better fairness or throughput values. By increasing CQI of a user temporarily, the instant achievable throughput of the user is calculated to be higher, and the metric value of the user increases, thus his chance to get a resource increases accordingly. Table 4.1 demonstrates the pseudo-code for the proposed scheduler algorithm.

---

Proposed Algorithm

---

1. **Input:** CQI feedback of the users,  $CQI_{k,n}$ , Requested Delay,  $Q_{k,n}$ , Packet Size,  $P_{k,n}$ .
  2. **Estimate:** Average throughput  $T_k(n)$  and Necessary delivery time  $D_k(n)$  for each user from (4.10).
  3. **for each** user  $k$
  4.     **if**  $D_k(n)$  smaller than  $Q_k$
  5.          $TCQI_{k,n}$  is equal to  $CQI_{k,n} + c$
  6.     **else**
  7.          $TCQI_{k,n}$  is equal to  $CQI_{k,n} - c$
  8. **Estimate:** Instant achievable throughput  $R_k(n)$  using  $TCQI_{k,n}$
  9.     **obtain**  $(k^*, n^*) = \operatorname{argmax} \frac{R_k(n)}{T_k(n)}$  from (4.7)
  10. **Return:** Resource allocation matrix (N\_RB x N\_UE).
- 

**Table 4.1 Proposed Scheduling Algorithm**

The necessary delivery time for a user's packet is calculated by dividing the packet size to current achievable throughput for the user. CQI feedback is used to obtain modulation and spectral efficiency of a user for each channel, and instantaneous throughput for each user is calculated using spectral efficiency. CQI is an indicator based on the SNR value of the user and it is sent to the eNodeB at the end of each TTI to inform it about the channel quality.

In the proposed algorithm, CQI is manipulated to increase or decrease the calculated instant throughput of a user for each resource block, and this increases or decreases the chance of a user being allocated a resource block according to the metric (4.7). Table 3.2 shows the MCS index and spectral efficiency values corresponding to CQI values for LTE-A network.

# Chapter 5

## 5. LTE System Level Simulator

To execute the simulations, the Vienna LTE System Level Simulator is used. There are a variety of simulators which are presented commercially in the market. Some of the equipment producers also have built their own solutions. There are also some other simulators implemented by some universities and research centers but they do not provide publicly available source codes. On the other hand, the Vienna LTE System Level Simulator is free of charge for academic usage and its source codes are open [38]. It is also supported by some big enterprises like Nokia Solutions and Networks, Kathrein Werke KG, and A1 Telekom Austria AG. These are the main reasons behind employing this simulator in the thesis work. Details of the simulator and simulation environment will be explained briefly in this chapter.

The applied simulator consists of three main blocks which are transmitter, channel model and receiver. Downlink transmission is emulated from transmitter block towards receiver block, and channel model block emulates the communication medium which links transmitter and receiver blocks. The simulator is used for simulating downlink communication and signaling and uplink connections are accepted as impeccable to be able to observe the downlink system better.

### 5.1 Blocks of the Simulator

Most of the pre-transmitting process is taken by the scheduler, it allots RBs to the users according to the UE feedback, and decides the appropriate MCS and the precoding for each user. After decision of necessary adjustments according to CQI values that show channel conditions of the users, the signals to be sent are encoded and transmission process is taken by the simulator.

The following channel models are upheld by the simulator: ITU Pedestrian (A & B), ITU Vehicular (A & B), AWGN (Additive White Gaussian Noise), Rayleigh fading and Winner Phase II+. The simulator can be used to simulate block fading channels and fast fading channels. The channel conditions are considered to be stable along a subframe (1ms) for block fading environment as in real life. For fast fading channel simulation, channel conditions are provoked timely with every signal being transmitted.

The receiver block of the simulator operates at the user side. After receiving the encoded signal, a variety of signal decoding algorithms are used to decode the signal. Original data is acquired after the decoding operation as well as other valuable channel information like BER, BLER and throughput.

## **5.2 Structure of the Simulator**

There are two main parts inside the structure of the simulator which are link-measurement model and link-performance model [39]. Link-measurement model is responsible for demonstrating link qualities coming from the UE evaluations, and it permits resource distribution and link adaptation. Link quality is evaluated for each subcarrier. The UEs calculate the necessary feedback such as CQI according to the SINR, and this feedback is used at the eNodeB side for accomplishing link adaptation. The link performance model pursues the link measurement model to anticipate BLER of the link according to the received SINR.

Using the object oriented programming advantages of MATLAB software, the simulator consists of classes (objects) each of which portrays an element in the LTE system. The network topology is created by setting up transition sites each containing three eNodeBs with a scheduler.

The scheduler sets up resources and appropriate MCSs for each UE connected to an eNodeB. On the UE hand, SINR is evaluated by the link measurement model for the assigned resource block. Later, CQI is computed according to these SINR values and BLER. With respect to the CQI feedback, scheduler needs to find the suitable MCS to fit BLER verge on the transmitter side. Moreover, BLER is used as an anticipation to calculate ACK/NACK values and these values are used to calculate the throughput of the link together with the transport block size. The output of the simulation gives out traces which depict throughput and error rates for the users.

### 5.3 Simulation Types

To be able to set up different size of simulations, the simulator presents three diverse types of simulations which require diverse computational complexity. These three simulation types are; Single downlink, Single cell Multi user, and Multi cell Multi user. Figure 5.1 depicts these simulation types.

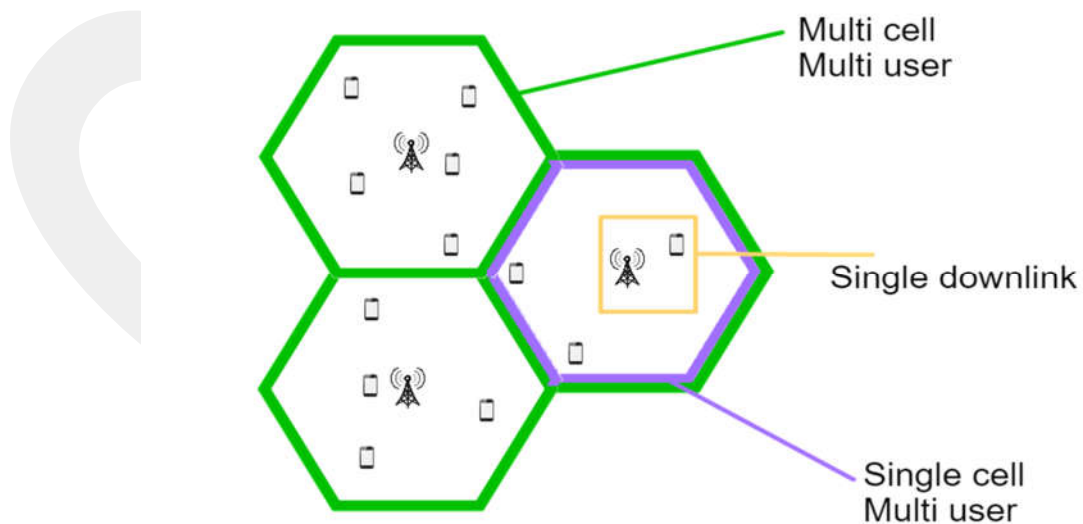

Figure 5.1 Simulation Types

The single downlink type simulates a connection between one UE and one eNodeB. This simulation type permits the examination of channel estimation and synchronization, MIMO gains, feedback, encoding and decoding models, and physical layer model.

The single cell multi user type simulates a connection among multiple UEs and one eNodeB. This simulation type permits the examination of receiver block as well as the effects of scheduling, MIMO resource allocation, and multiple user gains as expansion to the single downlink type simulation.

The multi cell multi user type simulates a connection among multiple UEs and multiple eNodeBs. As expected, this type of simulation requires more computation. It permits more rational examination about interference between the links, and effects of the scheduling algorithms on resource scheduling.

# Chapter 6

## 6. Performance Evaluations

In this work, we propose a new scheduling algorithm which is designed to improve throughput for the edge users while maintaining nice QoS fairness results. Hence, the simulations are built to demonstrate performances of some well-known scheduling algorithms as well as the proposed algorithm. Simulation parameters are given in Table 6.1.

<b>Simulation Parameters</b>	
Number of eNodeBs	3
Number of users per eNodeB	20-100
Simulation duration	50TTI
Bandwidth	20MHz
Carrier Frequency	800, 1800, 2100 MHz
Antenna Configuration	1x1 (SISO), 2x2 and 4x4 (MIMO)
UE speeds	5, 50, 100km/h
Performance Metrics	Edge TP, Peak TP, Cell Avg. TP, Jain's fairness index, QoS fairness index
Scheduling Algorithms	Proportional Fair, Round Robin, Best-CQI, CoMP with RR, Proposed Scheduler

**Table 6.1 Simulation Parameters**

The results of the simulations are evaluated with regard to the performance metrics given in Table 6.1. Edge throughput, peak throughput, cell average throughput, Jain's fairness index and QoS fairness index values of the diverse scheduling algorithms along with effects of mobility, carrier frequency and antenna configuration are given in the following sections. As a new approach

introduced in LTE-Advanced network, CoMP with Round Robin scheduling is also evaluated in the simulations.

## 6.1 Edge Throughput Results

The average edge throughput results are shown in Figure 6.1 according to different number of users in a cell. Edge Throughput demonstrates the results of resource allocation to the users who are closer to the cell edges. As expected, average edge throughput decreases as the number of users increases because the resources become scarce. Meanwhile, edge throughput is always 0 for Best-CQI algorithm since it allocates resources to the users with the best channel quality, and edge users cannot get any service as they have the worse channel quality because of fading channels problem in mobile networks.

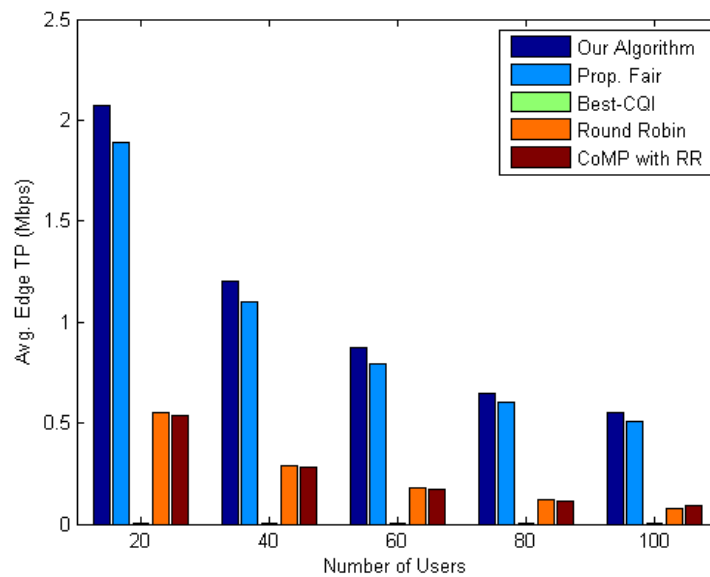

**Figure 6.1 Average Edge Throughput Performance of the Schedulers**

As shown in Figure 6.1, the proposed algorithm performs best and it is 9,2% better than the Proportional Fair algorithm in terms of edge user throughput. Moreover, these two algorithms outperform Round Robin, Best-CQI and CoMP with Round Robin algorithms especially if the number of users are smaller in a cell.

Figure 6.2 shows the approximate locations of the users in the cell area. Peak throughput is the value calculated for those users who are closest to the cell centers and it mainly affects the overall cell throughput.

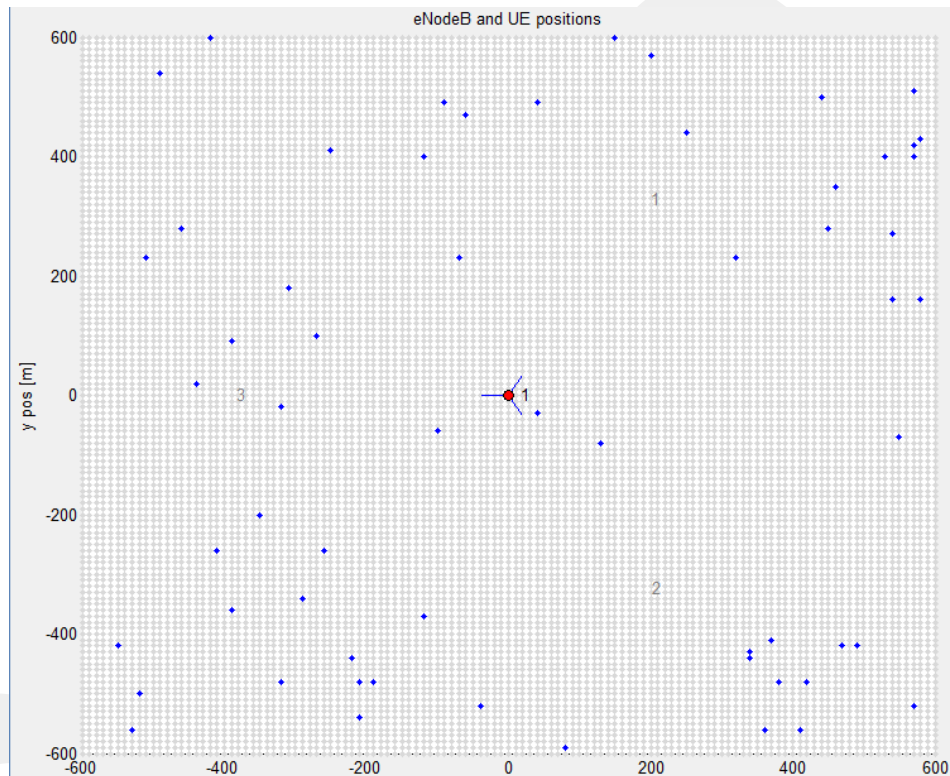
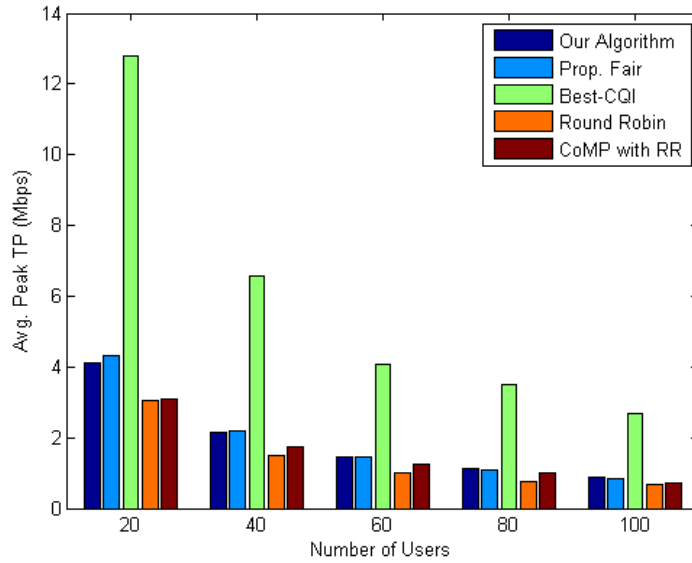

Figure 6.2 Positions of the UEs and the eNodeBs

## 6.2 Peak Throughput Results

The users who are closest to the cell center suffer least from fading channels problem, and they have the best channel quality when compared to other users. This leads to a better communication between central users and the eNodeB, and hence, they can get the maximum benefit, namely throughput from the eNodeB. Figure 6.3 shows the simulation results for central users scheduled by diverse algorithms.



**Figure 6.3 Average Peak Throughput Performance of the Schedulers**

Best-CQI algorithm performs best as it allocates the resources to the users with best channel qualities. Good channel quality means having high throughput results and this is the main reason of Best-CQI algorithm's high throughput values.

However, this causes very poor fairness results according to Jain's fairness metric [40] and our QoS fairness metric (6.9). Only users with good channel qualities are allocated resource blocks by Best-CQI algorithm, and oppositely edge users are never allocated. On the other hand, our algorithm provides very similar results when compared to Proportional Fair algorithm about peak throughput and it passes Proportional Fair when the number of users in the cell increases. Round Robin and CoMP with Round Robin provide close results to each other which are outperformed by Best-CQI algorithm. However, the coordinated multi point structure increases average peak throughput about 10% when compared to Round Robin.

## 6.3 Average Cell Throughput Results

Average cell throughput is one of the most important criteria in resource scheduling area of LTE systems. More throughput gained means that users are served better, having better experience from the network. However, there is another criterion, fairness, which is in a trade-off with throughput. The network has to serve all of its users without ignoring service requests of any user. A user with poor channel qualities might also request higher data rates. Therefore, the scheduling process has to take both of these criteria into consideration.

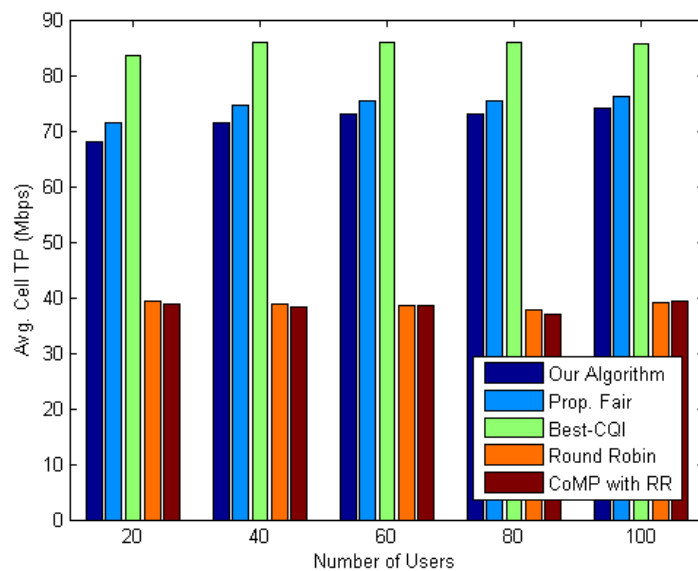

**Figure 6.4 Average Cell Throughput Performance of the Schedulers**

Figure 6.4 depicts average cell throughput achieved by the simulated schedulers. As mentioned above, Best-CQI algorithm reaches high throughput rates on the cell average, howbeit its fairness results are not as good as its throughput values. Our algorithm provides close results to PF which provides second good results for average cell throughput and our algorithm is better than RR, and CoMP algorithms according to the simulation results.

## 6.4 Jain's Fairness Metric Results

Jain's fairness metric estimates how impartial an algorithm is, about giving equal throughput to all the users being served. It estimates the fairness values for  $n$  users and  $x_i$  is the throughput value gained on the  $i^{th}$  channel.

$$J(x_1, x_2, \dots, x_n) = \frac{(\sum_{i=1}^n x_i)^2}{n \cdot \sum_{i=1}^n x_i^2} \quad (5)$$

Although Best-CQI algorithm provides high results about peak and cell throughput, it shows very poor performance about Jain's fairness. Our algorithm shows the best performance among all and Proportional Fair algorithm comes second with a 2% decreased performance. Round Robin and CoMP with Round Robin also provide reasonable results about fairness.

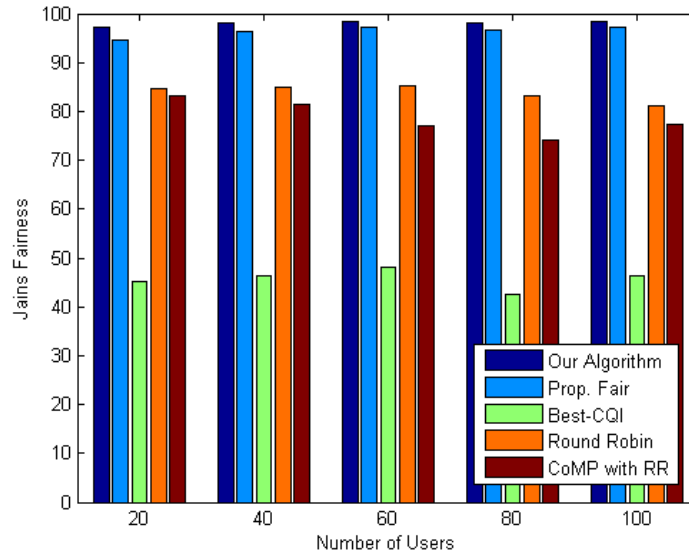

Figure 6.5 Jain's Fairness Index of the Schedulers

The reason of our algorithm performing the best about Jain's fairness index is that, while trying to fulfill QoS requirements of all the users inside a cell, our

algorithm allocates more resources to edge users and shares the resources out more equally among the users.

As mentioned above, Round Robin and CoMP with Round Robin provide acceptable results about Jain's fairness but this is about distributing resources numerically equal rather than maintaining close throughput levels for each user.

## 6.5 QoS Fairness Metric Results

QoS fairness is especially introduced in this work to examine performances of diverse scheduling algorithms about users' service requests and network experiences. QoS metric defined in (6.8) and (6.9) uses delay needs of users' packets which is very important for services like video streaming or online and mobile gaming.

Most of the classical algorithms do not have a mechanism that deals with QoS needs of users. While number and variation of mobile applications increase, QoS service demands of the users increase simultaneously, and the lack of this QoS-aware mechanism turns out to be a disadvantage about these classical algorithms. This is the main motivation beyond designing a novel, QoS-aware algorithm.

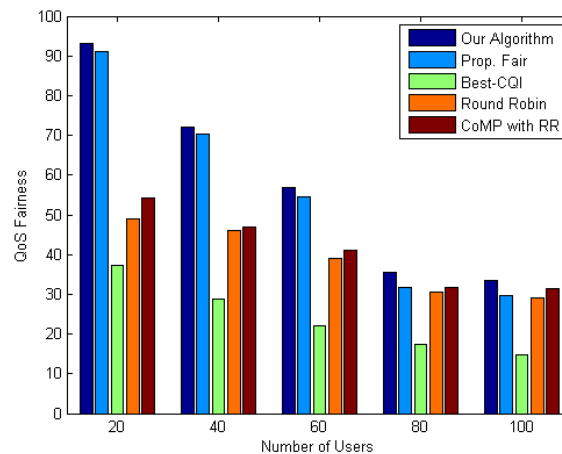

Figure 6.6 QoS Fairness Index of the Schedulers

As it can be seen from Figure 6.6, QoS fairness index decreases as the number of users increase. Proposed algorithm provides the highest results and outperforms Best-CQI, Round Robin and CoMP with Round Robin algorithms. It also produces about 5,5% higher results than Proportional Fair algorithm and it helps users to gain a continuous experience from the system.

On the other hand, CoMP with Round Robin provides better results than standard Round Robin and it starts to produce similar results to Proportional Fair algorithm as the number of users increases. It passes Proportional Fair and performs the second best when the number of users is 80 and over.

## **6.6 Effects of Mobility**

LTE network is developed to perform well under a range of diverse user speeds from about 5km/h to 120km/h. In the simulations, three level of user speeds are chosen to test out the performance of scheduling algorithms about mobility: 5km/h as average human walking speed, 50km/h as maximum urban driving speed and 100km/h as highway driving speed.

It can be observed from Figure 6.7 that, the average peak throughput supplied by each scheduler decreases as the speed of the users increase. This is an expected result of mobility, because the more speed of a user increases, the harder is it to maintain a good channel quality between the user and the eNodeB.

On the other hand, it can be seen that while Best-CQI algorithm provides best peak throughput results, its performance decreases dramatically according to increasing user speed. Other algorithms including our algorithm are more robust against mobility and they do not cause a big throughput loss which becomes about 2% smaller as the user speed increases.

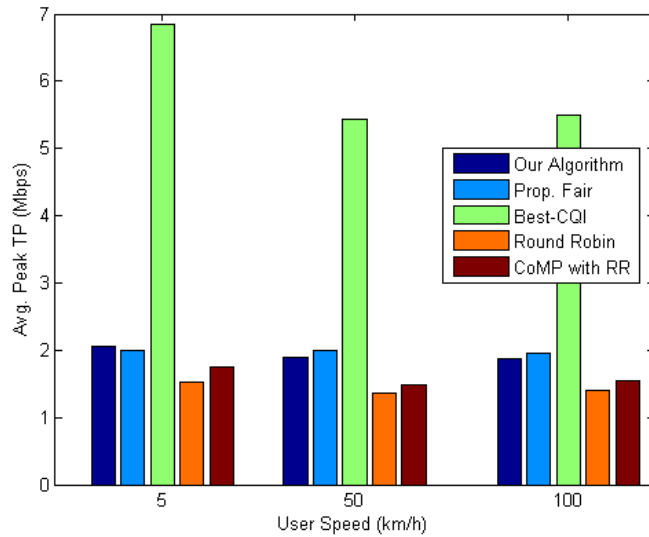

**Figure 6.7 Average Peak Throughput with Mobility**

Proposed algorithm and Proportional Fair produce similar results; proposed algorithm is 3% better than Proportional Fair when user speed is 5km/h, whilst Proportional Fair provides 1.8% better results on the average of diverse user speeds. CoMP with Round Robin gives about 10% better results than standard Round Robin but they provide linear throughput results.

The average edge throughput results under different user speeds are shown in Figure 6.8. The average edge throughput supplied by each scheduler tends to increase as the speed of the users increase. This is also a natural result of mobility, because as the speed of a user increases, the harder is it to maintain good channel quality between the user and the eNodeB. This means there are going to be more users behaving as edge users as the user speed increases.

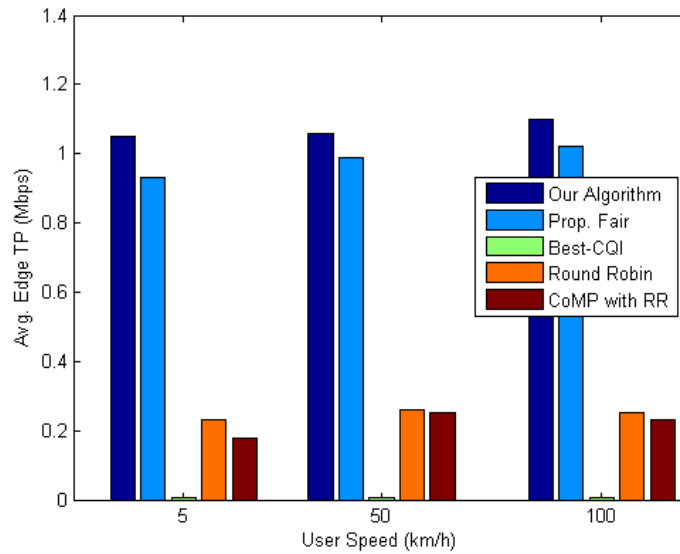

**Figure 6.8 Average Edge Throughput with Mobility**

It can be seen from Figure 6.8 that Best-CQI algorithm again does not provide any throughput for edge users as mentioned above. Proposed algorithm and Proportional Fair algorithm again outperform other three algorithms when edge throughput is the subject. Proposed algorithm provides the best results about edge throughput which is about 9.2% higher than its competitor, Proportional Fair algorithm, on the average for different user speeds.

Average cell throughput results are another important measure to show the effects of mobility of the users on scheduling algorithms. Figure 6.9 depicts average cell throughput results for three speed levels mentioned above, along with performance of scheduling algorithms.

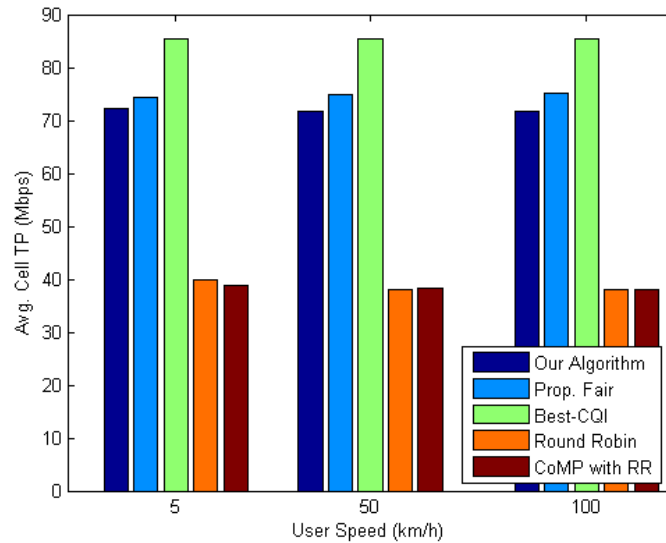

**Figure 6.9 Average Cell Throughput with Mobility**

Since the Best-CQI algorithm provides highest peak throughput rates, it also produces the best cell throughputs as awaited. The reason of consistent results provided by Best-CQI under different user speeds is its allocation of resources to the users with best channel qualities only. Proposed algorithm performs acceptable results when compared to Proportional Fair algorithm. It causes a decrease about 3.5% in the overall cell throughput, but instead it permits a large increase in average edge throughput.

Round Robin and CoMP with Round Robin also provide close results to each other. Round Robin algorithm pretends to produce better results when the user speeds are lower, on the other hand user speeds of 50km/h and 100km/h do not cause a dramatic change in the overall cell throughput.

Observing the Jain's fairness results along with mobility depicts that proposed algorithm performs the best, at a ratio of 1,8% better than Proportional Fair while outperforming other three algorithms. The fairness results can be seen in Figure 6.10.

The main goal of the proposed algorithm of increasing QoS experience of edge users also means allocating more resources to the edge users. This is the main reason behind higher fairness results produced by the proposed algorithm, on the other hand, this also causes a decrease in the overall throughput as expected by the trade-off between fairness and throughput.

As being a well-known algorithm for providing good fairness results, Proportional Fair again comes second after the proposed algorithm. Round Robin and CoMP with Round Robin provide reasonable results while Best-CQI cannot maintain acceptable results.

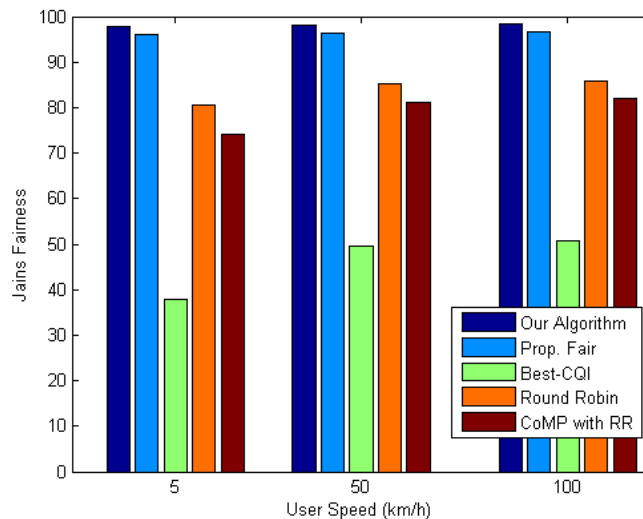

**Figure 6.10 Jain's Fairness Index Results with Mobility**

It can be observed from Figure 6.10 that, all of the algorithms tend to produce better fairness results with the increasing user speeds. Increasing speed means experiencing poor channel conditions for users, and as mentioned above, this means more users are starting to act as edge users if speed increases. Allocating more resources to edge users allows the fairness index to increase.

Figure 6.11 depicts average QoS fairness values for the scheduling algorithms conjointly with mobility. It can be seen that proposed algorithm again performs the best, with a 5% higher ratio than the Proportional Fair algorithm.

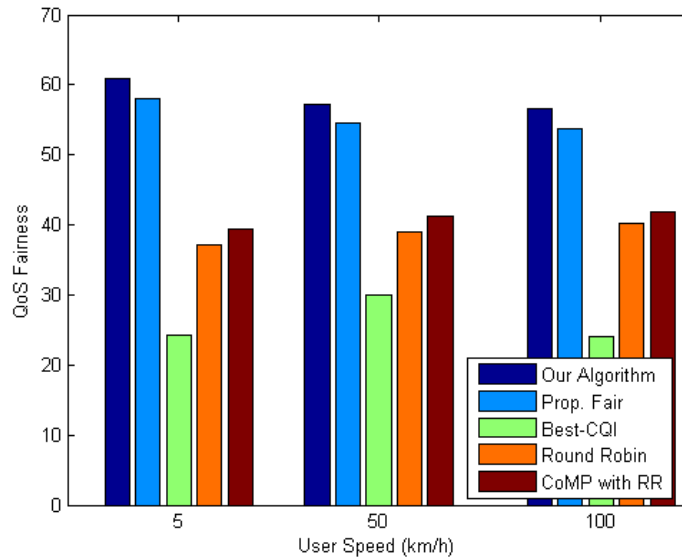

**Figure 6.11 QoS Fairness Index Results with Mobility**

As the user speeds increase, quality of the channel conditions decrease oppositely. This is the main reason behind providing users with necessary packet delivery times becomes harder according to increasing speeds. As in the Jain's fairness index results, Best-CQI produces the lowest QoS fairness results, which are outperformed by both Proportional Fair algorithm and the proposed algorithm. Round Robin and CoMP with Round Robin provide acceptable results about QoS fairness when compared to Best-CQI algorithm.

From the simulation results involving user mobility, it can be observed that user channel conditions tend to become worse with increasing user speeds. As a result, average peak throughput and average cell throughput decrease while average edge throughput increases.

## 6.7 Effects of Carrier Frequency

LTE networks deployed in various countries work in diverse carrier frequency bands which appears in a range between 700MHz and 3500MHz. The LTE-A network which has been deployed in Turkey by three mobile operating companies are built on 800MHz to 2100MHz frequency band range. In the simulations, 800MHz, 1800MHz and 2100MHz frequency bands were chosen to demonstrate the LTE-A network used in Turkey, and as well show the effects of carrier frequency on throughput, Jain's fairness and QoS fairness performances of the examined scheduling algorithms.

The results of the simulations executed using different carrier frequency bands show that, average peak throughput tends to increase according to the increase of carrier frequency bands for Best-CQI algorithm. It stays stable for Proportional Fair and the proposed algorithm and tends to decrease for Round Robin and CoMP with Round Robin algorithms. Figure 6.12 depicts the average peak throughput results of the five evaluated scheduling algorithms along with the examined carrier frequency bands.

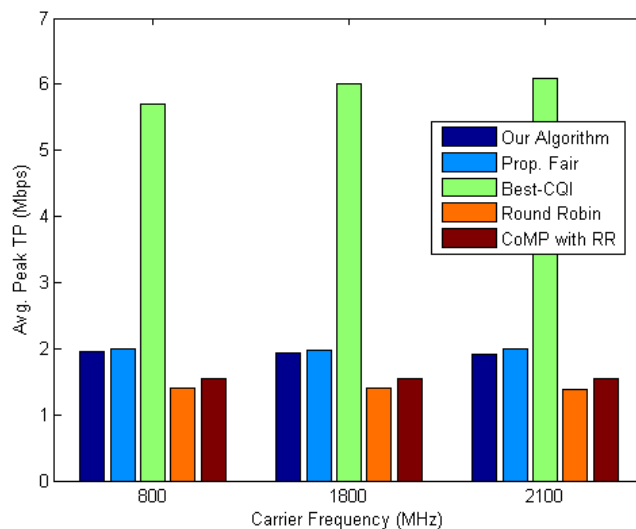
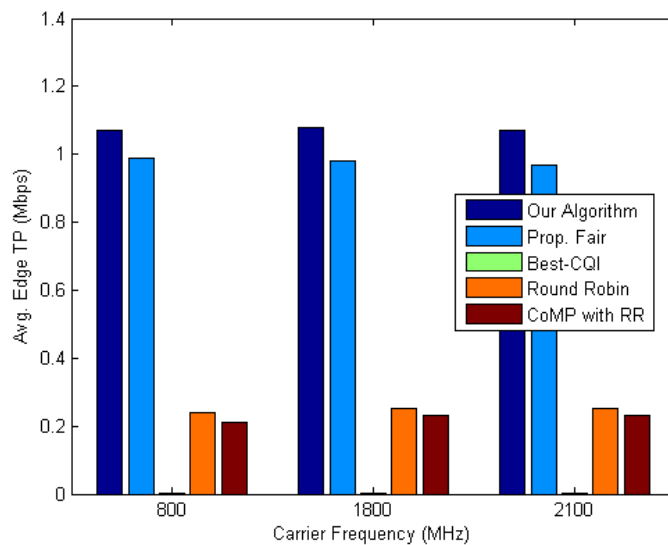

Figure 6.12 Average Peak Throughput with Carrier Frequency

It can be observed from Figure 6.12 that, users experiencing better channel conditions get better throughput from the network when carrier frequency becomes higher. This can be figured out from the increasing peak throughput results of the Best-CQI algorithm since it always allocates the resource blocks to the users with best channel conditions.

Being the fairest algorithms, Proportional Fair and the proposed algorithm try to share the resource blocks more equally among the users, and this eventuates with short changes about peak throughput for these two algorithms. Round Robin and CoMP with Round Robin algorithms do not take channel conditions into account while allocating resources and this causes peak throughput to decrease as the carrier frequency bandwidth increases oppositely to the Best-CQI algorithm.

Conversely to the results of peak throughput, average edge throughput tends to increase for Round Robin and CoMP with Round Robin schedulers. Withal, it still remains stable for Proportional Fair and the proposed algorithm, again because these are the fairest algorithms. Best-CQI algorithm, nevertheless, does not provide any edge throughput under any carrier frequencies.



**Figure 6.13 Average Edge Throughput with Carrier Frequency**

Figure 6.13 demonstrates that best edge throughput results are achieved at 1800MHz carrier frequency band among the three frequencies occupied in the simulations. Proposed algorithm provides the best results which are 10% higher than its closest follower, Proportional Fair algorithm. It also outperforms Round Robin and CoMP with Round Robin algorithms with over 330% better results. Best-CQI algorithm again does not provide any edge throughput to be compared with other scheduling algorithms.

The simulations exhibit that the average cell throughput tends to stand similar and it is not affected heavily by changing the carrier frequency bands. Figure 6.14 represents the average cell throughput values for evaluated algorithms under 800MHz, 1800MHz and 2100MHz carrier frequencies.

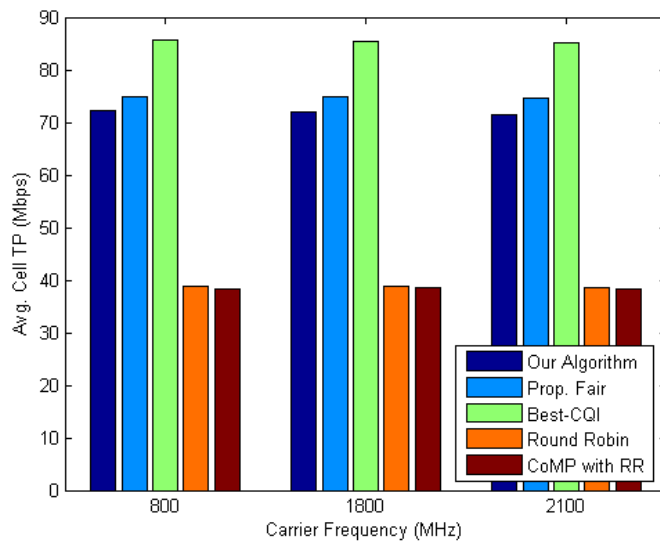

**Figure 6.14 Average Cell Throughput with Carrier Frequency**

It can be observed from Figure 6.14 that, Best-CQI algorithm creates its best results when the carrier frequencies are lower, because the users who are closer to the eNodeB can maintain better channel qualities and they are allocated more resource blocks with lower carrier frequencies. This ends up with better

throughput results with lower channel frequencies. Round Robin and CoMP with Round Robin performs their best under 1800MHz carrier frequency.

Proportional Fair and the proposed algorithm work in a similar manner trying to allocate users that can achieve high instant throughput in each TTI and having smaller average throughput in a past window. They generate slightly better results under lower carrier frequencies.

The investigation of results about Jain's fairness index under different carrier frequencies show that the proposed algorithm generates the highest results at the end of all of the simulations. Proportional Fair algorithm produces second highest results, that is about 2% smaller than the proposed algorithm on the average. The proposed algorithm and Proportional Fair algorithm both generate their highest fairness results on 1800MHz. The reason of this is; the users tend to have channel conditions closer to each other, and more users start to act like having medium channel qualities.

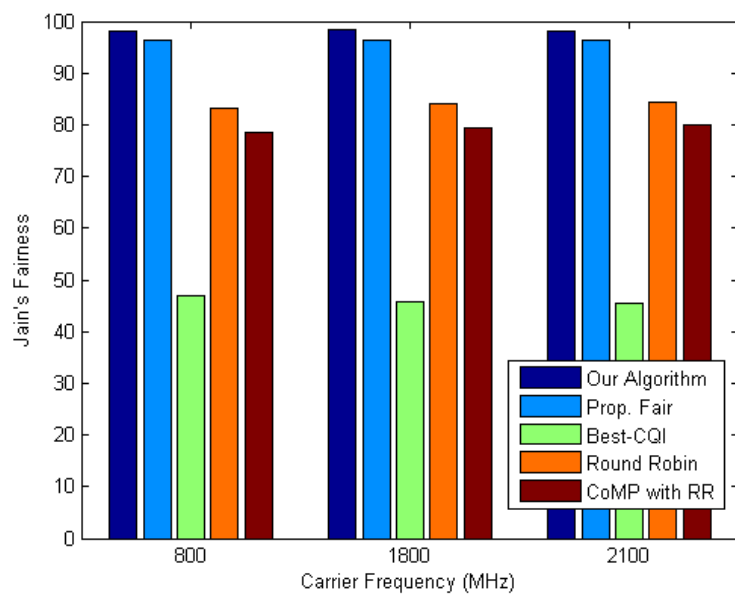

**Figure 6.15 Jain's Fairness Index Results with Carrier Frequency**

Round Robin and CoMP with Round Robin algorithms generate their highest fairness results at 2100MHz frequency band, however there is not a definite explanation for this since they allocate the resource blocks to the users blindly without controlling their channel conditions. Best-CQI scheduler provides its highest fairness results on 800MHz bandwidth because it can allocate more users as the users close to the eNodeB experience better channel conditions on lower bandwidths.

The simulation results representing QoS fairness results along with carrier frequencies are show in Figure 6.16. The proposed algorithm performs the best with about 5,5% higher results than the Proportional Fair algorithm on the average. Proportional Fair algorithm becomes the second with 55% QoS fairness index results on the average. The proposed algorithm, Proportional Fair algorithm and Best-CQI algorithm generate their highest QoS fairness index results on 2100MHz bandwidth. The reason to this is that, the users which are closer to the cell edges can get better channel qualities with higher carrier frequencies and they can experience a better quality-of-service as the carrier frequency increases.

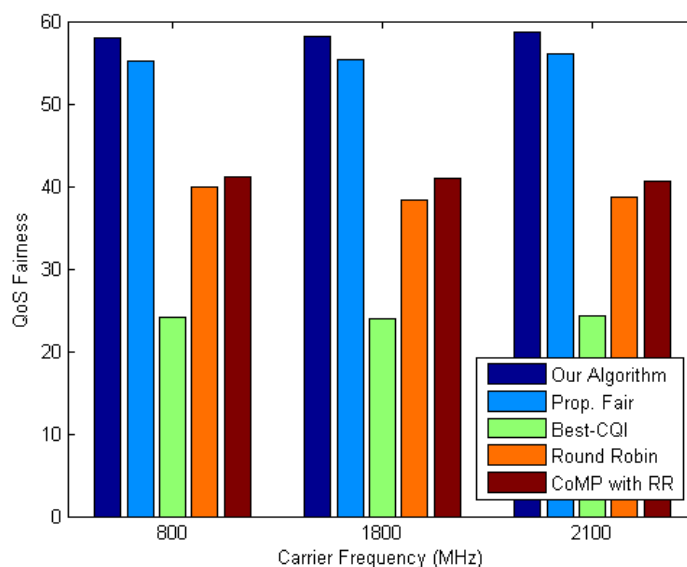

**Figure 6.16 QoS Fairness Index Results with Carrier Frequency**

Round Robin and CoMP with Round Robin algorithms generate their highest QoS Fairness index results on 800MHz frequency. On the average, the proposed algorithm outperforms Best-CQI, Round Robin and CoMP with Round Robin algorithms by generating about 59% QoS fairness results on the overall.

## 6.8 Effects of Antenna Configuration (MIMO)

In the design phase of LTE network, Multiple Input – Multiple Output (MIMO) has been proposed to develop the throughput of the system by using two or more antennas to transmit and receive two or more different data flows simultaneously both in UE side and the eNodeB side [26]. During the simulations, we have employed Single Input – Single Output (SISO, 1x1) and MIMO (2x2 and 4x4) antenna configurations to observe the effects of MIMO on the network.

The effects of MIMO on the average edge throughput of the network can be found in Figure 6.17. MIMO affects edge throughput results dramatically, though Best-CQI algorithm still does not provide any throughput for edge users.

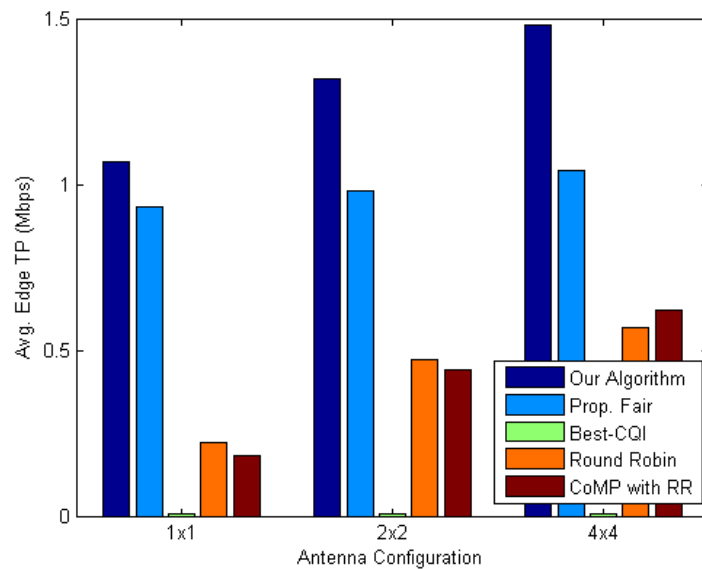

**Figure 6.177 Average Edge Throughput with MIMO**

The biggest improvement of edge throughput is observed with the proposed algorithm with about 23,5% increase from 1x1 to 2x2 and 12,5% increase from 2x2 to 4x4 antenna configurations. CoMP with RR provides its highest results and passes Round Robin with 4x4 MIMO. Proportional Fair algorithm also increases edge throughput with MIMO, however the rice is limited when compared to proposed scheduler and Round Robin algorithms.

The results of simulations which depicts the average cell throughput values according to antenna configuration can be found in Figure 6.18. From the average edge throughput values examined above, it is expected to occur a serious change in the average cell throughput values.

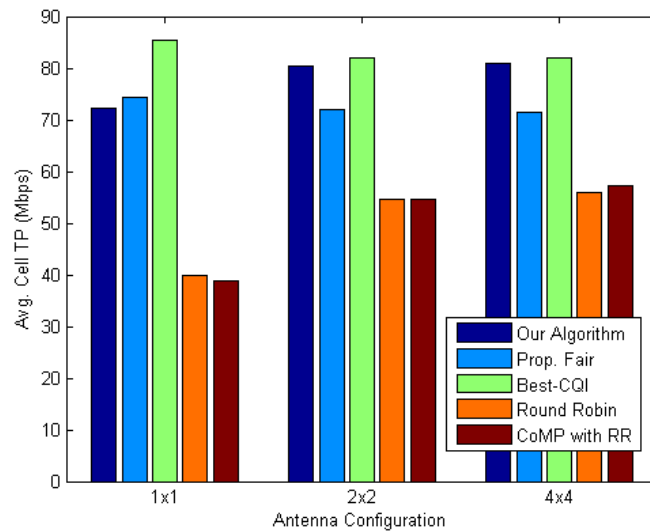

**Figure 6.18 Average Cell Throughput with MIMO**

The average cell throughput tends to change highly when moving from 1x1 to 2x2 antenna configuration. For the proposed algorithm, Round Robin and CoMP with Round Robin algorithms, average cell throughput increases. On the other hand, cell throughput decreases for Best-CQI and Proportional Fair algorithms.

Figure 6.19 demonstrates the performances of examined algorithms about Jain's fairness index along with different antenna configurations. Moving from 1x1 SISO to 2x2 MIMO brings a valuable increase to the Jain's fairness index results of every examined algorithm. On the other hand, moving from 2x2 MIMO to 4x4 MIMO does not provide a notable gain, though it still generates higher results on the fairness results of all of the algorithms.

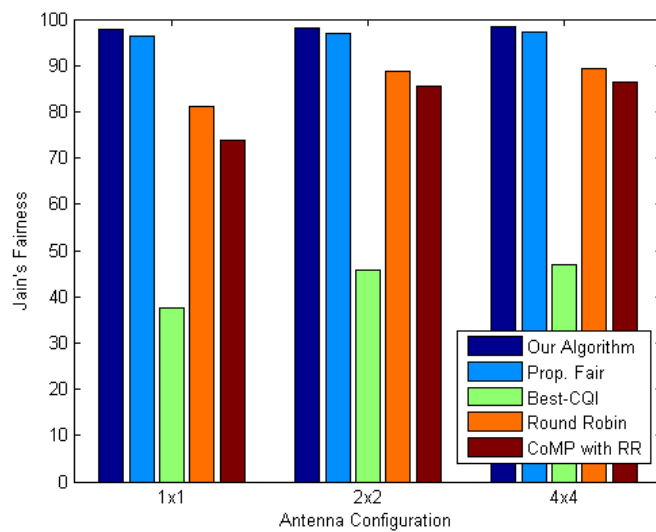
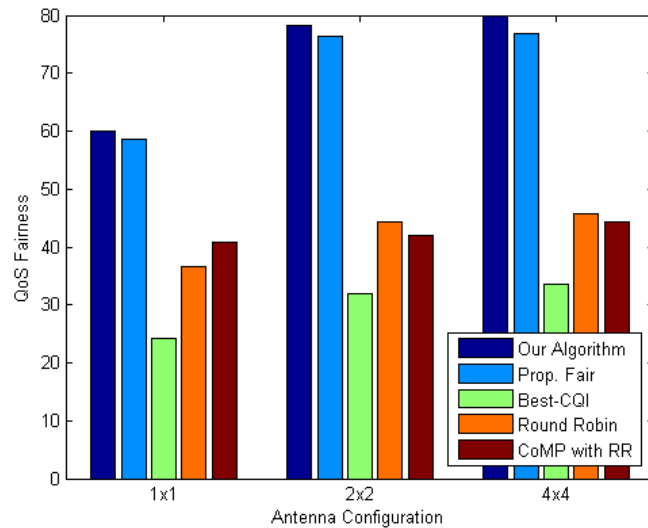

**Figure 6.19 Jain's Fairness Index Results with MIMO**

From the executed simulations, it can be understood that, Jain's fairness index is mostly dependent on the edge throughput results of the algorithms. By this fact, it is expected that the fairness results will increase for the algorithms that has a bigger impact on edge throughput with MIMO, which are Best-CQI, Round Robin and CoMP with Round Robin.

The simulation results demonstrating the QoS fairness results of the inspected algorithms are shown in Figure 6.20. Different from Jain's fairness index, QoS fairness takes the delay needs of the users into consideration, that is, how many packet of a user could have been delivered on time is the main focus of QoS fairness. With respect to this concept, since MIMO is designed to increase the

overall throughput of the network, it is also expected to increase the QoS fairness by providing more throughput to the users.



**Figure 6.20 QoS Fairness Index Results with MIMO**

Moving from 1x1 to 2x2 antenna configuration generates a serious increase of the QoS fairness index for all of the inspected algorithms. On the other hand, the change about QoS fairness increases lesser with 4x4 MIMO. It can be observed from the figure that, proposed algorithm generates the highest results with all of the antenna configurations.

# Chapter 7

## 7. Conclusions and Discussion

In this thesis, we introduce a new fairness metric, QoS fairness, which is designed to measure how fine users' delay requests are fulfilled for the network services they are using such as video streaming or online game playing. We also introduce a novel algorithm, which is based on classical Proportional Fair algorithm, however it uses packet size and delay information of each user to decide the priority in resource allocation.

We have run simulations with different delay values, different packet sizes, different number of users and different scheduling algorithms which are given in Table 6.1. The simulation results indicate that, the proposed algorithm produces very good results about edge throughput, Jain's fairness index and QoS fairness index, especially when the number of users is smaller, but also the highest of the overall.

<i>Advantages</i>	<i>Disadvantages</i>
Edge TP increase 10%	Peak TP decrease 1,8%
Jain's fairness increase 2%	Avg. Cell TP decrease 3,5%
QoS fairness increase 6%	

**Table 7.1 Proposed Algorithm vs. Proportional Fair Algorithm**

The proposed algorithm specifically aims at providing better QoS fairness results than the Proportional Fair algorithm, which is taken as reference since it is the algorithm that provides best fairness values about Jain's fairness among all. Table 7.1 shows the advantages and disadvantages of the proposed scheduler against PF algorithm after simulations. The simulations demonstrate that, allocating the network resources according to the delay needs and packet sizes of the users brings several advantages over the standard Proportional Fair algorithm.

Proposed algorithm results 10% higher edge throughput, 2% higher Jain's fairness index and 6% higher QoS fairness index values when compared to Proportional Fair algorithm. On the other hand, there is still a 1.8% decrease in average peak throughput. The reason of this decrease is giving some more of the resource blocks to the edge users instead of users closer to eNodeBs, in order to fulfill their QoS demands. Since channel quality is not very good for edge users, they can get less throughput from the eNodeB, and this brings an expected but still limited decrease in peak and overall cell throughput.

Considering the trade-off between fairness and throughput, this 1.8% decrease in the peak throughput can be acceptable when it is compared to the 10% increase in the edge throughput and 6% increase in the QoS fairness index.

The rearrangement of the resource allocation according to delay and packet sizes of the users brings notable advantages about edge throughput and QoS fairness over Proportional Fair algorithm. On the other hand, the proposed algorithm does not cause a big decrease in overall peak throughput and cell average throughput.

# Bibliography

- [1] T. J. Barnett, A. Sumits, S. Jain, and U. Andra, “Cisco Visual Networking Index (VNI) Update Global Mobile Data Traffic Forecast,” Cisco VNI White Paper, 2015.
- [2] A. Akan, E. Onen, and L. F. Chaparro, “Time-Frequency Based Robust OFDM Channel Equalization,” 2007, no. Eusipco, pp. 493–496.
- [3] M. Rupp, *The Vienna LTE-Advanced Simulators*, 1st ed. Springer Singapore, 2016.
- [4] J. M. Holtzman, “Asymptotic Analysis of Proportional Fair Algorithm,” 2001 12th IEEE Int. Symp., no. 1, pp. 33–37, 2001.
- [5] H. Kim, K. Kim, Y. Han, and S. Yun, “A Proportional Fair Scheduling for Multicarrier Transmission Systems,” *Vehicular Technology Conf. 2004*, vol. 1, pp. 409–413, 2004.
- [6] Z. Sun, C. Yin, and G. Yue, “Reduced-Complexity Proportional Fair Scheduling for OFDMA Systems,” 2006 Int. Conf. Commun. Circuits Syst., no. 60472070, pp. 1221–1225, 2006.
- [7] U. Toseef, T. Weerawardane, A. Timm-Giel, C. Gorg, and H. Kroner, “Adaptive Fair Radio Interface Scheduling for LTE Networks,” 2012 9th Int. Conf. High Capacit. Opt. Networks Enabling Technol. HONET 2012, pp. 21–26, 2012.
- [8] S. Sudheep and B. Rebekka, “Proportional Equal Throughput Scheduler-A Very Fair Scheduling Approach in LTE Downlink,” 2014 Int. Conf. Inf. Commun. Embed. Syst. ICICES 2014, no. 978, 2015.
- [9] S. A. Alqahtani and M. Alhassany, “Performance Modeling and Evaluation of Novel Scheduling Algorithm for LTE Networks,” 2013 IEEE 12th Int. Symp. Netw. Comput. Appl., pp. 101–105, 2013.
- [10] D. Liu and Y. H. Lee, “An Efficient Scheduling Discipline for Packet Switching Networks Using Earliest Deadline First Round Robin,” *Proc. - Int. Conf. Comput. Commun. Networks, ICCCN*, vol. 2003–January, pp. 5–10, 2003.
- [11] B. Liu, H. Tian, and L. Xu, “An Efficient Downlink Packet Scheduling Algorithm for Real Time Traffics in LTE Systems,” 2013 IEEE 10th Consum. Commun. Netw. Conf. CCNC 2013, pp. 364–369, 2013.

- [12] S. Trabelsi, A. Belghith, and F. Zarai, "Performance Evaluation of a Decoupled-Level with QoS-Aware Downlink Scheduling Algorithm for LTE Networks," 2015 IEEE Int. Conf. Data Sci. Data Intensive Syst., pp. 696–704, 2015.
- [13] H. A. Akyildiz, B. Akkuzu, and H. A. Cirpan, "A QoS-Aware Reconfigurable LTE MAC Scheduler," 2014 IEEE 22nd Signal Process. Commun. Appl. Conf. (SIU 2014), pp. 1467–1470, 2014.
- [14] Y. Zaki, T. Weerawardane, C. Görg, and A. Timm-giel, "Multi-QoS-Aware Fair Scheduling for LTE," Veh. Technol. Conf. (VTC Spring), 2011 IEEE 73rd, 2011.
- [15] N. Ferdosian, M. Othman, B. Mohd, and K. Yeah, "Throughput-Aware Resource Allocation for QoS Classes in LTE Networks," *Procedia - Procedia Comput. Sci.*, vol. 59, pp. 115–122, 2015.
- [16] M. Al-Shuraifi, H. Al-Zayadi, O. Lavriv, and M. Klymash, "Improving QoS in MAX C / I Scheduling Using Resource Allocation Type 1 of LTE," *Exp. Des. Appl. CAD Syst. Microelectron. (CADSM)*, 2015 13th Int. Conf., pp. 12–14, 2015.
- [17] K. Soni and A. Tyagi, "A Suboptimal QoS Aware Multiuser Scheduling for 3GPP LTE Network," 2015 Second Int. Conf. Adv. Comput. Commun. Eng., 2015.
- [18] X. Wu, X. Han, and X. Lin, "QoS Oriented Heterogeneous Traffic Scheduling in LTE Downlink," *IEEE ICC 2015 - Mob. Wirel. Netw. Symp.*, pp. 3088–3093, 2015.
- [19] Z. Jiang, W. Zhang, and S. Gao, "An Improving Strategy for LTE Downlink Scheduling Algorithms Based on QoS Requirement," *Commun. Qual. Reliab. (CQR)*, 2015 IEEE Int. Work. Tech. Comm., no. 1, 2015.
- [20] Y. Wang and H. Huang, "A QoS-Based Fairness-Aware Downlink Scheduling in LTE-Advanced," 2014 Int. Conf. Network-Based Inf. Syst., pp. 470–475, 2014.
- [21] S. Blake, "An Architecture for Differentiated Services," RFC 2475, 1998.
- [22] P. Trimintzios, I. Andrikopoulos, and G. Pavlou, "An Architectural Framework for Providing QoS in IP Differentiated Service Networks," *Integr. Netw. Manag. Proceedings*, 2001 IEEE/IFIP Int. Symp., 2001.

- [23] I. Mahadevan and K. M. Sivalingam, "Quality of Service Architectures for Wireless Networks: IntServ and DiffServ Models," *Parallel Archit. Algorithms, Networks*, 1999. (I-SPAN '99) Proceedings. Fourth Int., 1999.
- [24] M. Nohrborg, "LTE," 2016. [Online]. Available: <http://www.3gpp.org/technologies/keywords-acronyms/98-lte>. [Accessed: 06-Jun-2016].
- [25] V. Eerola, "LTE Network Architecture," *Netmanias*, 2008. [Online]. Available: [http://www.tutorialspoint.com/lte/lte\\_network\\_architecture.htm](http://www.tutorialspoint.com/lte/lte_network_architecture.htm). [Accessed: 04-Jun-2016].
- [26] J. Wannstrom, "LTE-Advanced," 2013. [Online]. Available: <http://www.3gpp.org/technologies/keywords-acronyms/97-lte-advanced>. [Accessed: 06-Jun-2016].
- [27] "TechTalkThai." [Online]. Available: [https://www.techtalkthai.com/wp-content/uploads/2014/12/qualcomm\\_carrier\\_aggregation.jpg](https://www.techtalkthai.com/wp-content/uploads/2014/12/qualcomm_carrier_aggregation.jpg). [Accessed: 06-Jun-2016].
- [28] Telesystem Innovations, "LTE in a Nutshell: The Physical Layer," White Paper, 2010.
- [29] I. Poole, "Orthogonal Frequency Division Multiplexing," 2016. [Online]. Available: <http://www.radio-electronics.com/info/rf-technology-design/ofdm/ofdm-basics-tutorial.php>. [Accessed: 06-Jun-2016].
- [30] A. Ghosh, J. Zhang, R. Muhamed, and J. G. Andrews, *Fundamentals of LTE*, Prentice Hall, 2010.
- [31] "Method and Apparatus for Performing Resource Allocation in Wireless Communication System," 2014. [Online]. Available: <http://www.google.ch/patents/WO2014123335A1?cl=en>. [Accessed: 03-Jun-2016].
- [32] S. Zarei, "LTE: Channel Coding and Link Adaptation," *Ausgewählte Kapitel der Nachrichtentechnik*, WS 2009/2010, pp. 1–14, 2009.
- [33] "Downlink Control Channel." [Online]. Available: <https://www.mathworks.com/help/lte/ug/downlink-control-channel.html>. [Accessed: 01-Jun-2016].
- [34] "Structure of LTE Turbo Code." [Online]. Available: [https://www.researchgate.net/figure/290182597\\_fig7\\_Structure-of-LTE-turbo-code-with-Rc13-a-turbo-encoder-and-b-turbo-decoder](https://www.researchgate.net/figure/290182597_fig7_Structure-of-LTE-turbo-code-with-Rc13-a-turbo-encoder-and-b-turbo-decoder). [Accessed: 12-Jun-2016].

- [35] R. Subramanian, P. Ghosal, S. Barua, S. Xing, S. Cong, H. Al Kim, and K. Sandrasegaran, "Survey of LTE Downlink Schedulers Algorithms in Open Access Simulation Tools Ns-3 and LTE-Sim," *IEEE Commun. Surv. Tutorials*, vol. 7, no. 2, pp. 1–16, 2015.
- [36] P. Xue, P. Gong, J. H. Park, D. Park, and D. K. Kim, "Max-min Fairness Based Radio Resource Management in Fourth Generation Heterogeneous Networks," *2009 9th Int. Symp. Commun. Inf. Technol. Isc. 2009*, pp. 208–213, 2009.
- [37] L. Gavrilovska and D. Talevski, "Novel Scheduling Algorithms for LTE Downlink Transmission," *2011 19th Telecommun. Forum, TELFOR 2011 - Proc. Paper*, pp. 398–401, 2011.
- [38] J. C. Ikuno, M. Wrulich, and M. Rupp, "System Level Simulation of LTE Networks," *IEEE Veh. Technol. Conf.*, 2010.
- [39] C. Mehlführer, J. Colom Ikuno, M. Šimko, S. Schwarz, M. Wrulich, and M. Rupp, "The Vienna LTE Simulators - Enabling Reproducibility in Wireless Communications Research," *EURASIP J. Adv. Signal Process.*, vol. 2011, no. 1, p. 29, 2011.
- [40] R. Jain, A. Duresi, and G. Babic, "Throughput Fairness Index: An Explanation," *ATM Forum Contrib.*, vol. 45, pp. 1–13, 1999.